

ES-AHZ Serie

ES-AHZ01

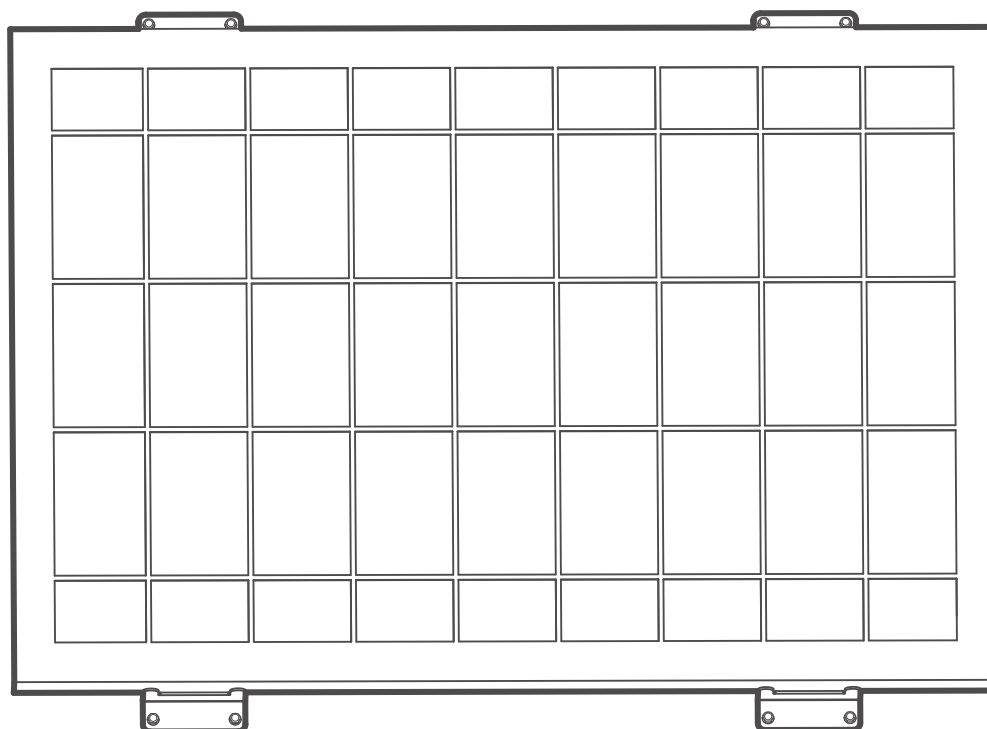

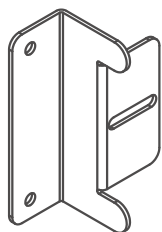

4x

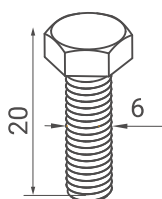
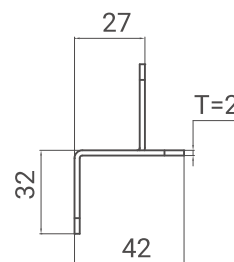
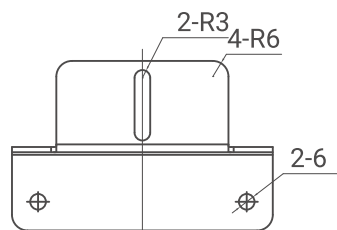
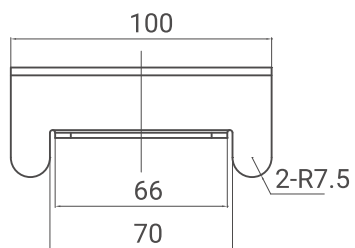

M6
Sechskantschraube

4x



M6
Sechskantmutter

4x



M8
Sechskantschraube

8x

Werkzeuge (nicht inkl.) :



Gabelschlüssel
für Größe M6 und M8



Akkuschrauber

1

Die Z-Halterungen mit den M6 Sechskantschrauben auf dem Solarpanel befestigen.

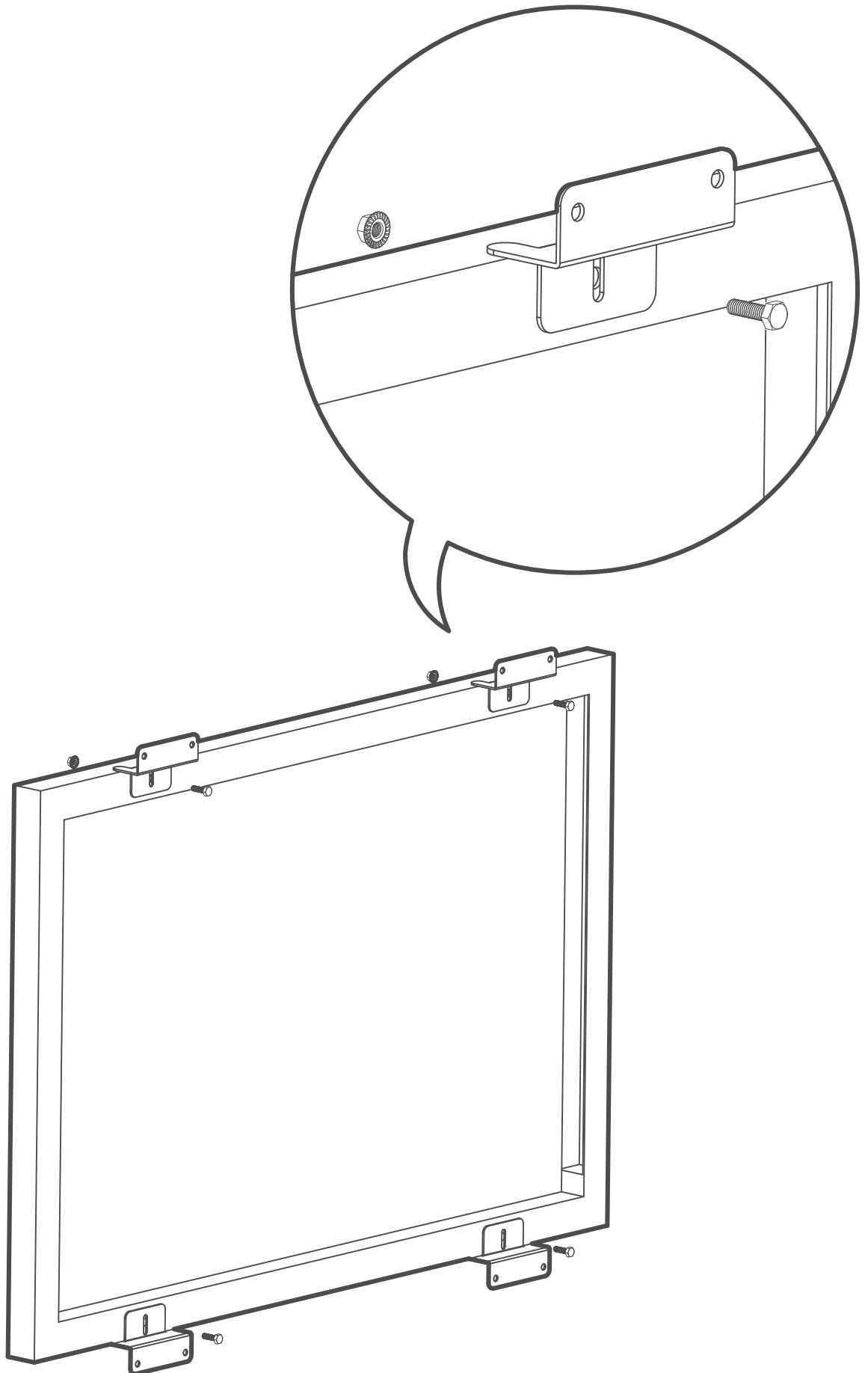

2

Die Z-Halterungen auf dem Dach des Wohnmobils oder auf einer Oberfläche mit den M8 Sechskantschrauben befestigen.

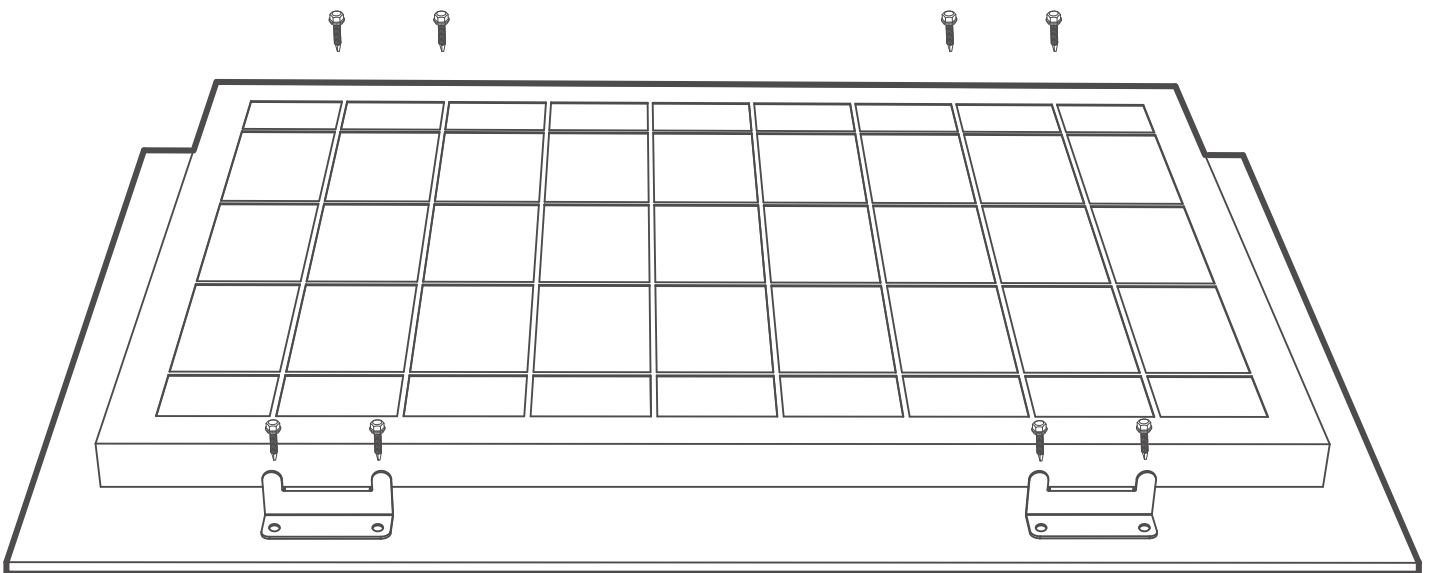
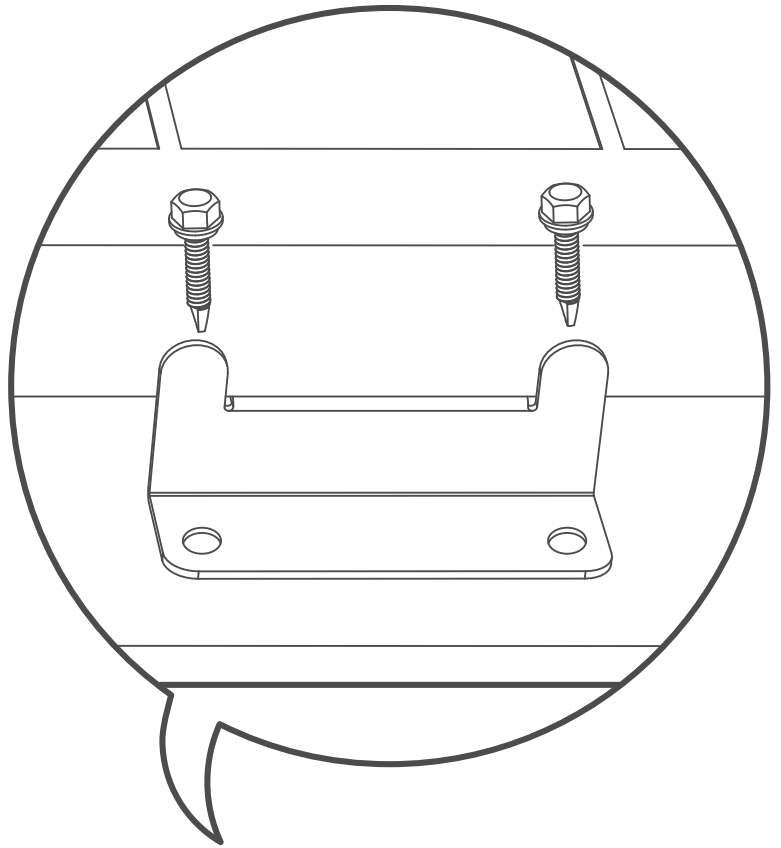

3 Fertig!

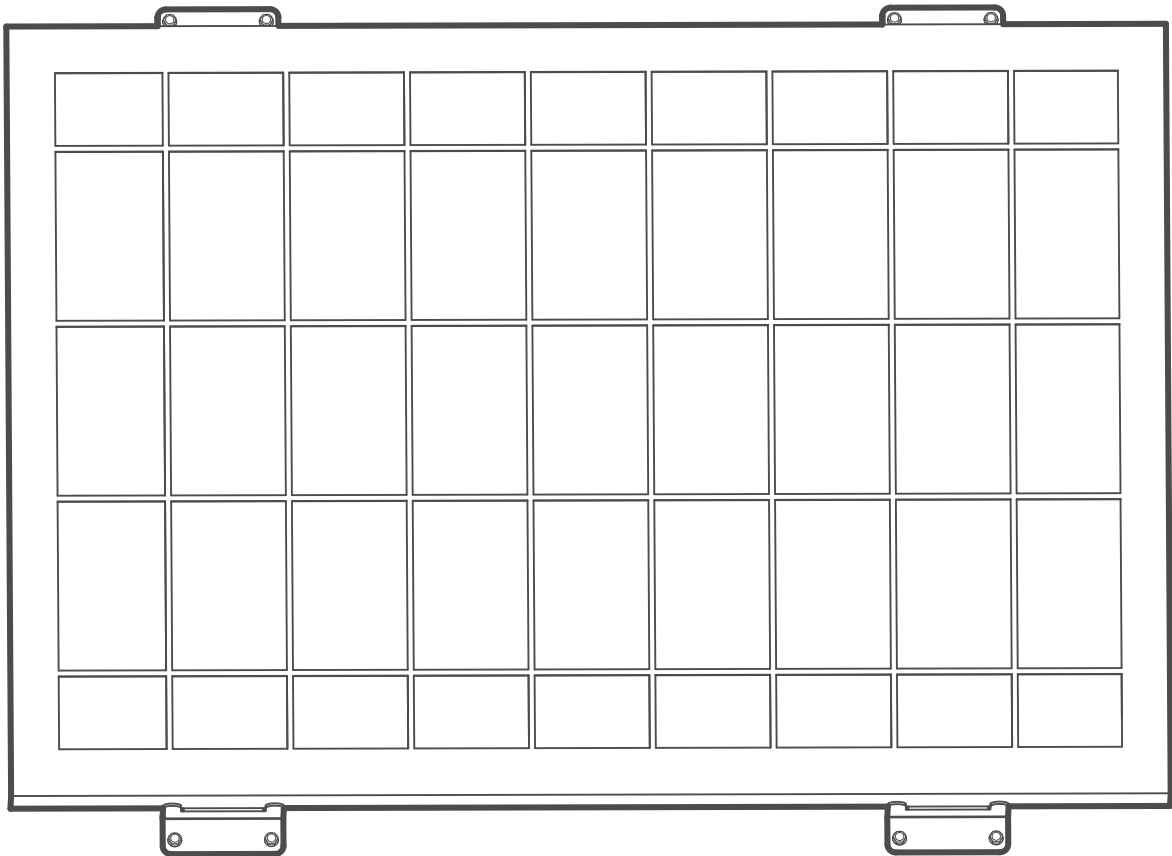
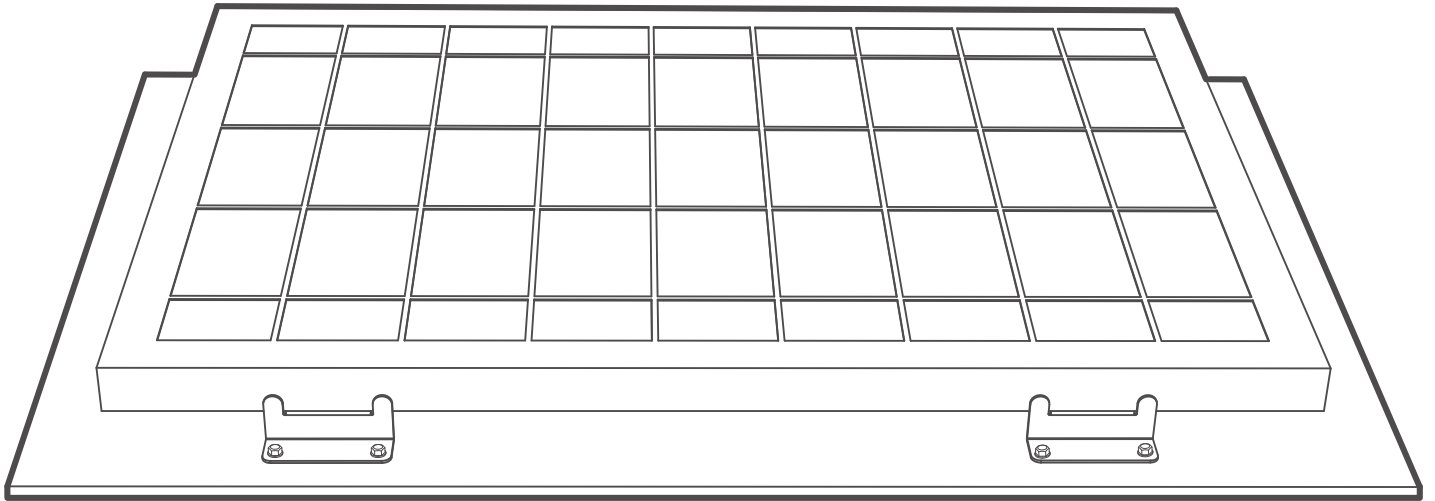



Power your life !



SolarV GmbH
info@solarv.de
www.solarv.de