

ES-AHZ serie

ES-AHZ01

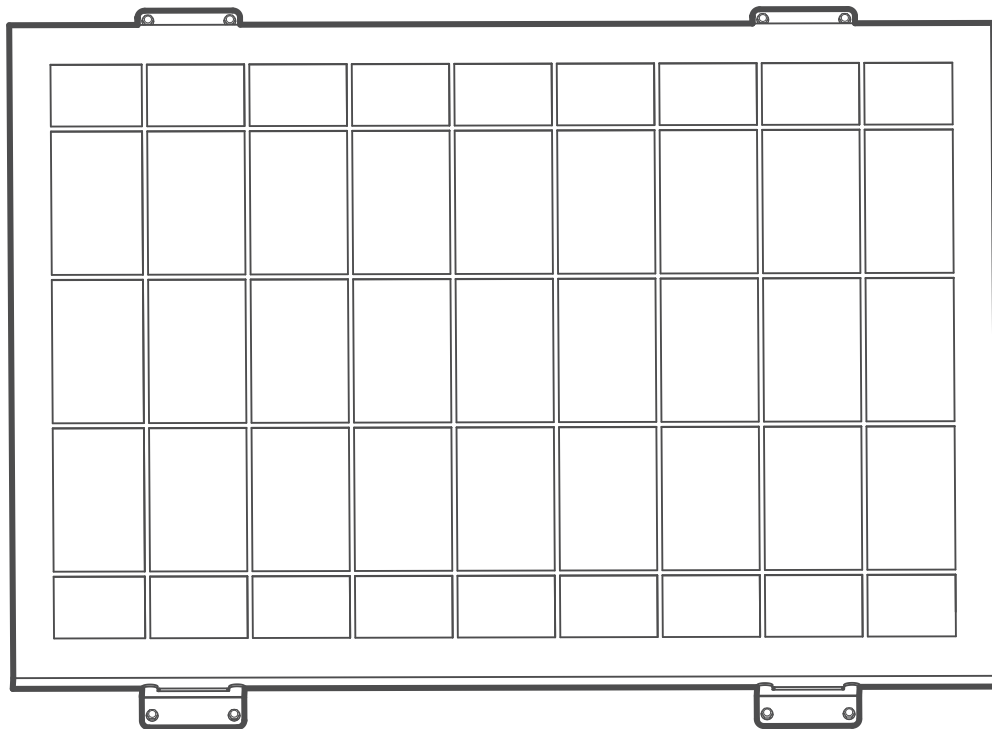

ES-AHZ01

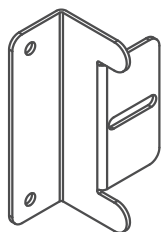

4x

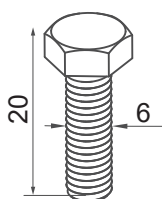
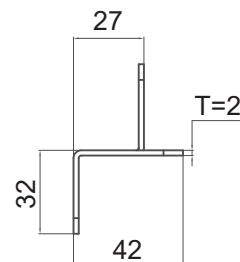
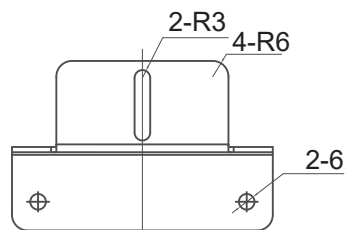
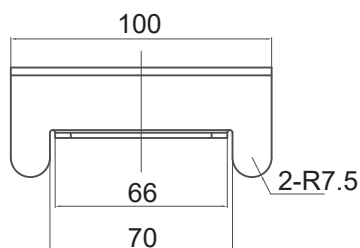

M6
Hexagonal Bolt

4x

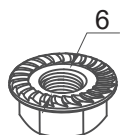

M6
Hexagonal Nut

4x



M8
Hexagonal Screw

8x

Tools (not included) :



Open-End Wrench
for Sizes M6 and M8



Cordless Screwdriver

1

Mount the Z-Brackets with the M6 hexagonal bolts onto the solar panel.

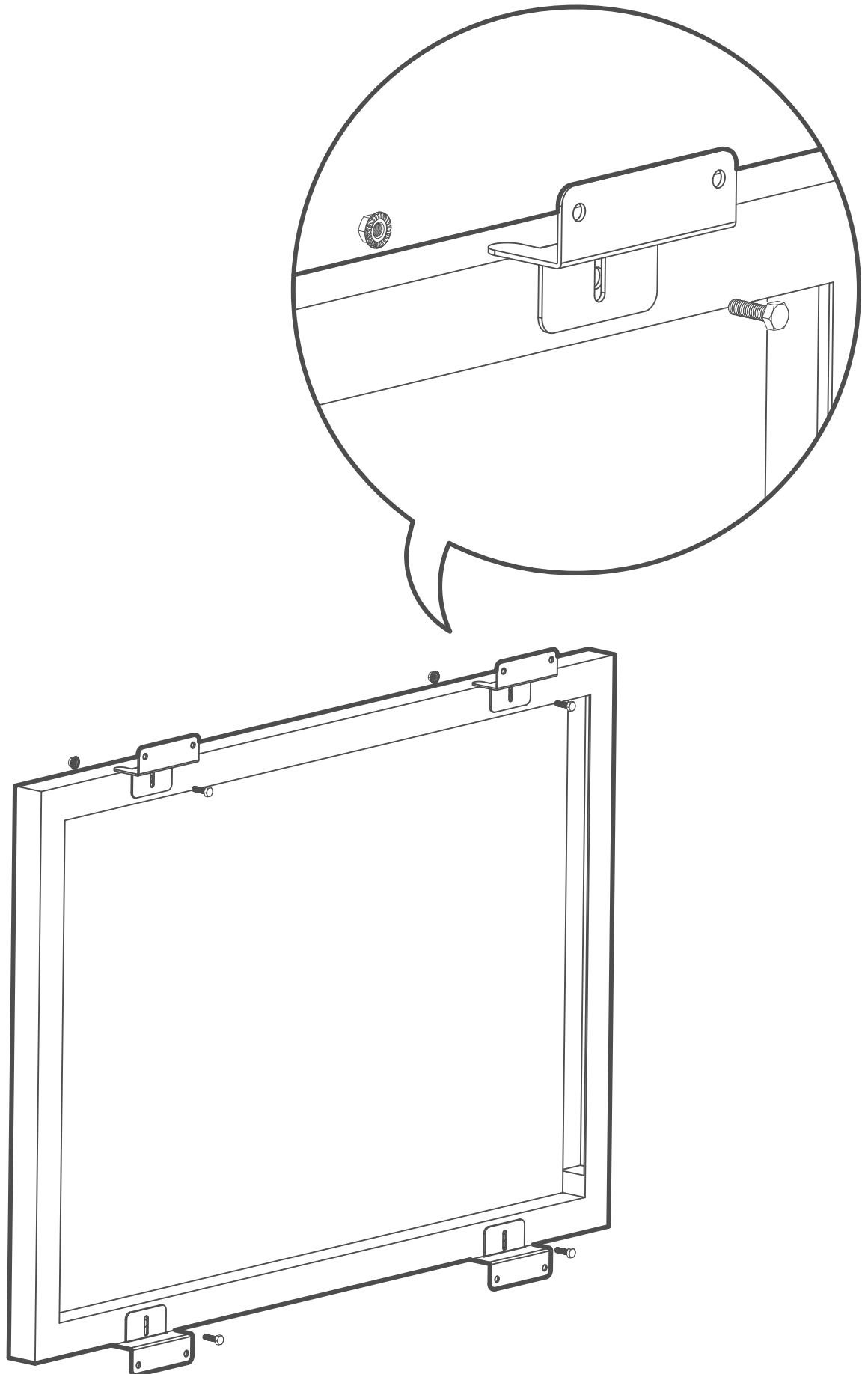

2

Mount the Z-Brackets onto the roof of the caravan or a flat surface with a M8 hexagonal screw.

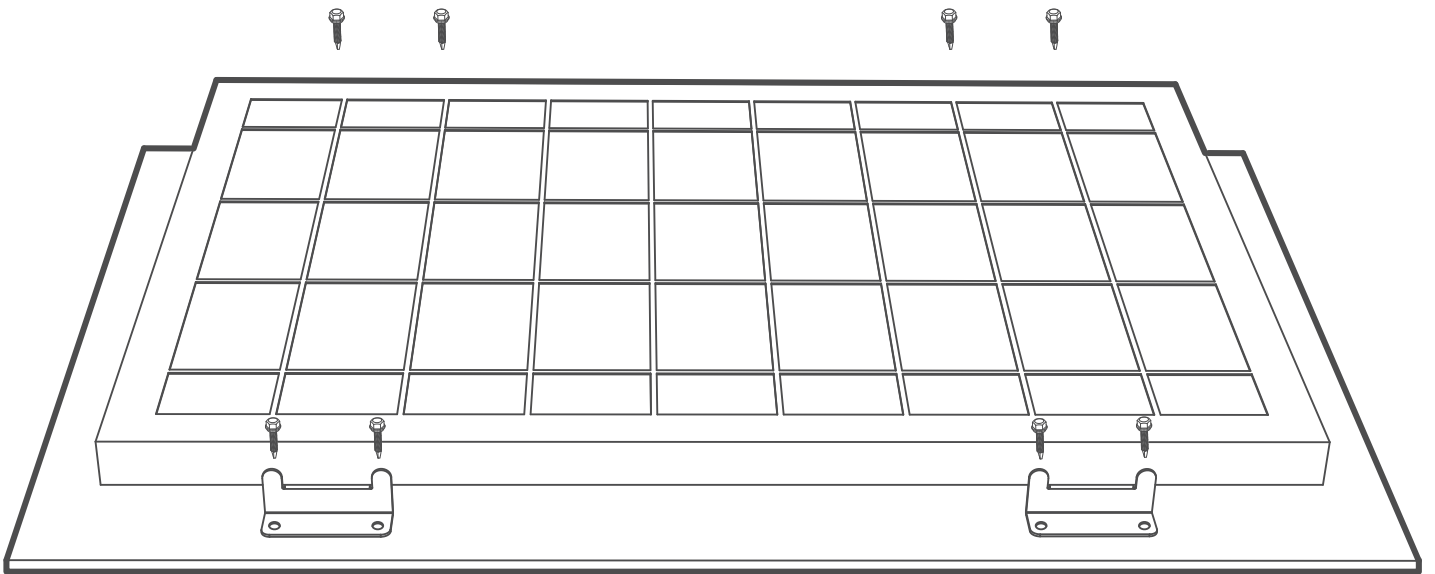
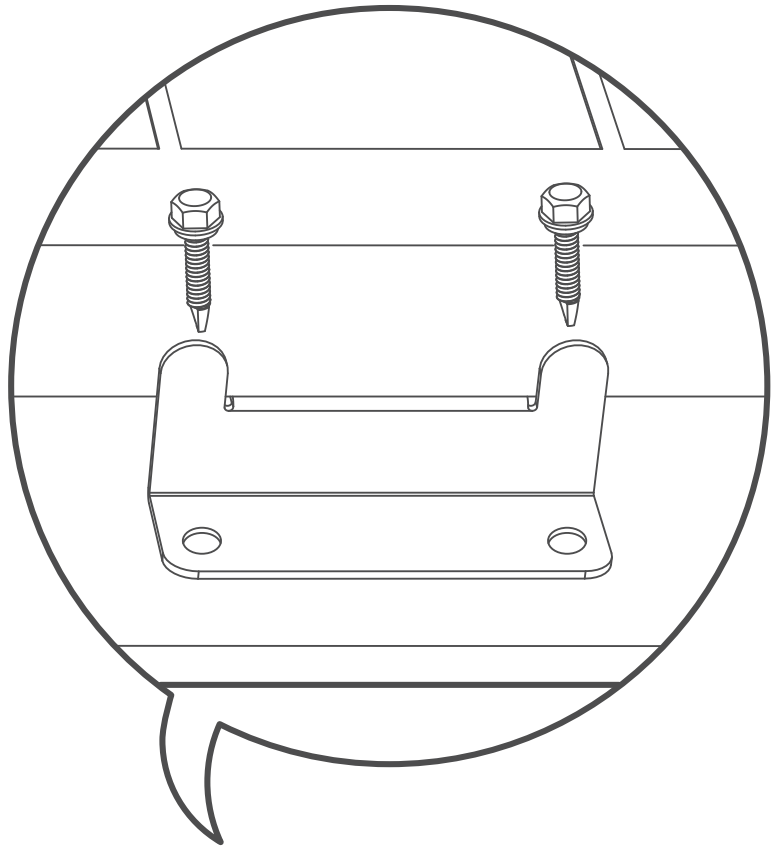

3

Completed

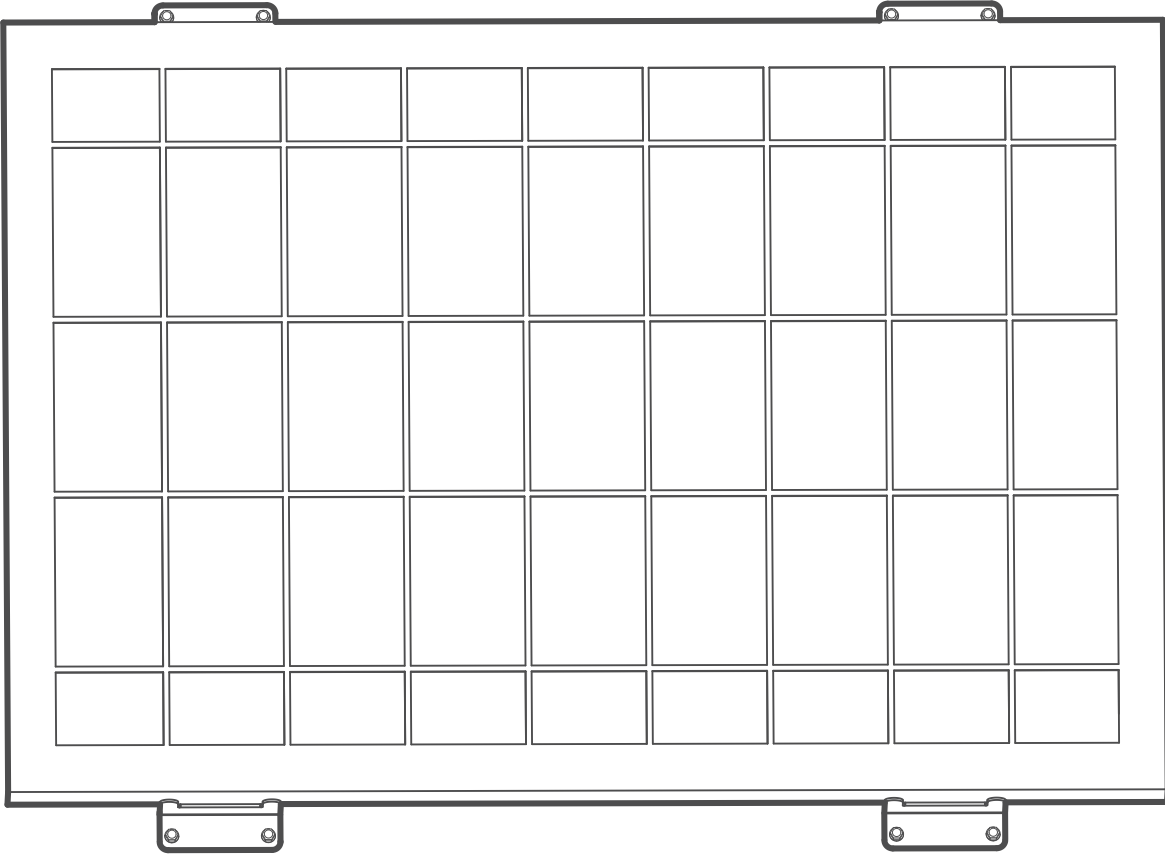
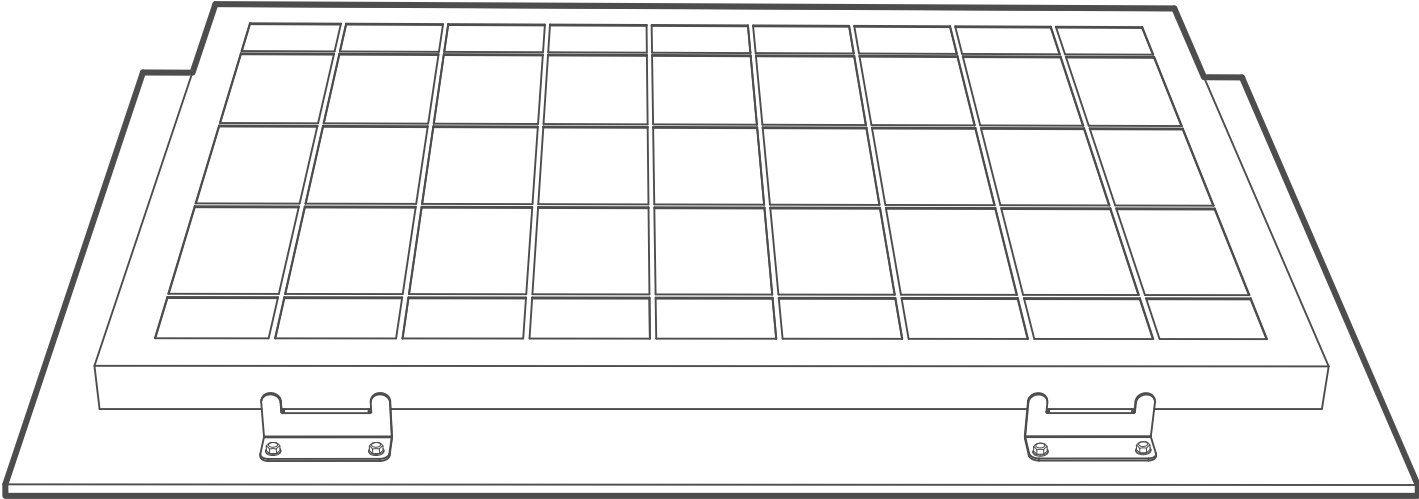



Power your life !



SolarV GmbH
info@solarv.de
www.solarv.de