

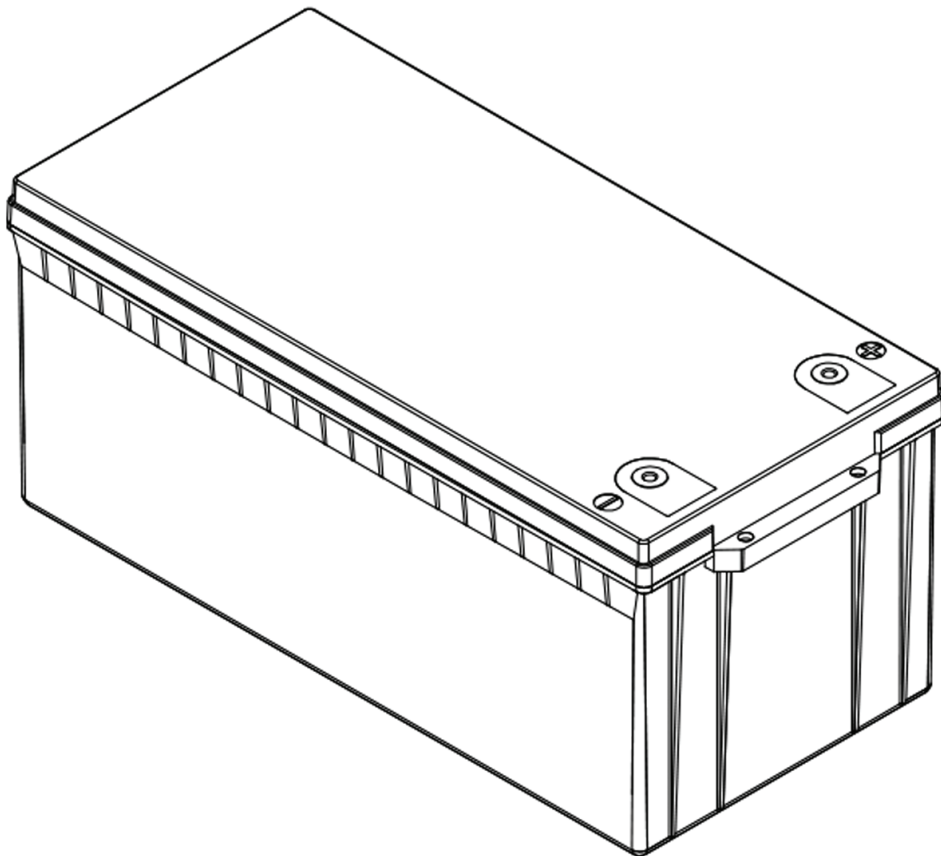

LIFEPO4 BATTERY

25.6V 150AH

EN



Art.-Nr. : 4924150



solarV

LiFePO4 Battery 25.6V 150Ah

Dimension (mm)

➤ LiFePO4 Battery 25.6V 150Ah

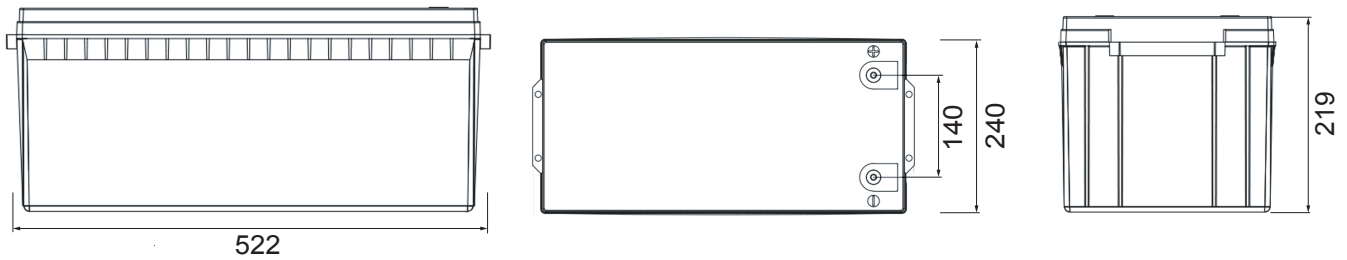

SolarV[®] Lithium iron phosphate (LiFePO₄ or LFP) batteries are considered to be more environmentally friendly energy storage than traditional lead-acid batteries, and they comply with the European RoHS regulations. Lithium storage batteries boast excellent safety, reliability and high efficiency. The high number of cycles ensures a long lifespan and up to 80% usable capacity without deep discharge. The integrated BMS in our LiFePO₄ battery ensures a high level of protection functions to safeguard against over-voltage and overcharging.

The SolarV[®] LiFePO₄ batteries offer a proven advantage with their unparalleled energy storage to weight ratio – a weight savings of over 60% compared to AGM/Gel batteries. With the newly integrated Bluetooth communication feature, it enables operational monitoring through our Smart App for iOS and Android devices. Recommended applications include campervans, boats, PV systems, recreational applications and uninterruptible power supplies (UPS).

Special features

- High energy density with low weight – 60% lighter than AGM/gel batteries
- Absolutely maintenance-free operation
- Integrated Bluetooth for connectivity – operational monitoring at any moment.
(Max distance 30m)
- Integrated BMS with numerous protection features
- Up to 80% usable capacity without deep discharge
- Up to 3 times as many cycles as conventional lead-acid batteries
- Self-discharge < 5% per month
- Product warranty: 2 years

Technical Specifications

Electrical Parameters

Nominal Voltage	25.6V
Rated Capacity	150Ah
Energy	3840 Wh
Resistance	≤35m Ω
Efficiency	≥0.98
Cycle Life (1C,80%DOD,25°C)	>2000 cycles @1C, 80% DOD
Self Discharge	<5% per Month
Max.Cell in Series/Parallel	8S/ 1P

Discharge Parameters

Continuous Discharge Current	150A
Pulse Discharge Current	170A(<10S)
Recommended Volt. Disconnect	20V
BMS Discharge Cut-off Voltage	20V
Reconnect Voltage	24V
Short Circuit Protection	300-800us

Temperature Parameters

Discharge Temperature	-20°C to 60°C
Charge Temperature	0°C to 55°C
Storage Temperature	-20°C to 60°C
BMS High Temperature Cut-off	65°C

Mechanical Parameters

Dimension(L×W×H)	522x240x219mm
	20.55x 9.45x 8.62"
Weight	29kg
Terminal Type	M8
Battery Housing	ABS
Housing Protection	IP65
Cell Type-Chemistry	LiFePO ₄ Cell
Communication	Bluetooth

Charge Parameters

Charge Method	CC-CV
Charge Voltage	28.4~29.2V
Recommended Float Voltage	27~27.6V
Recommended Charge Current	50A
Maximum Charge Current	150A
BMS Charge Cut-off Voltage	30V

Technical Diagrams

DIFFERENT RATE DISCHARGE CURVE (25 °C)

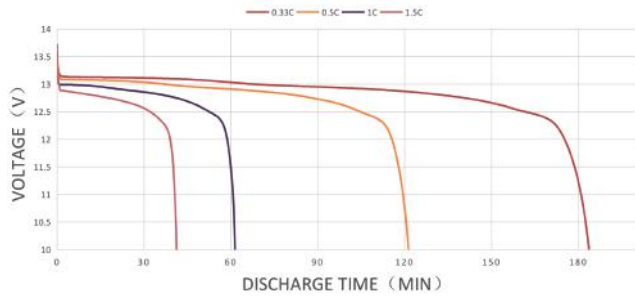

DIFFERENT TEMPERATURE DISCHARGE CURVE (0.5C)

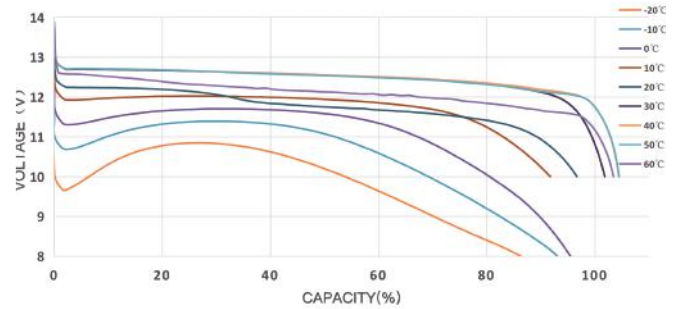

STATE OF CHARGE CURVE (0.5C, 25°C)

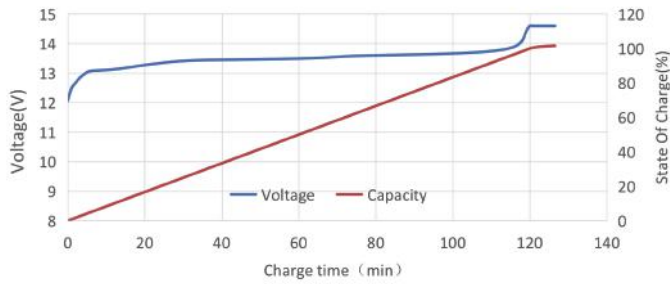

STATE OF CHARGE CURVE (0.5C, 25°C)

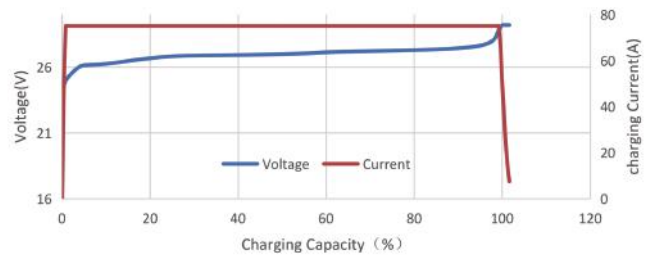

DIFFERENT DOD DISCHARGE CYCLE LIFE CURVE (0.5C)

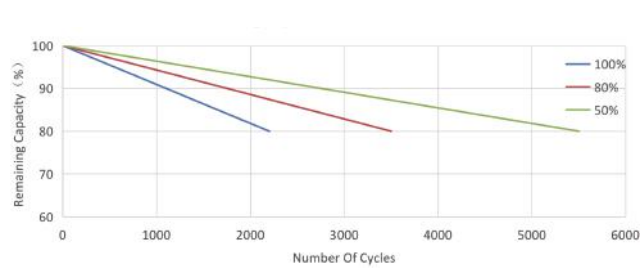

DIFFERENT TEMPERATURE SELF-DISCHARGE CURVE

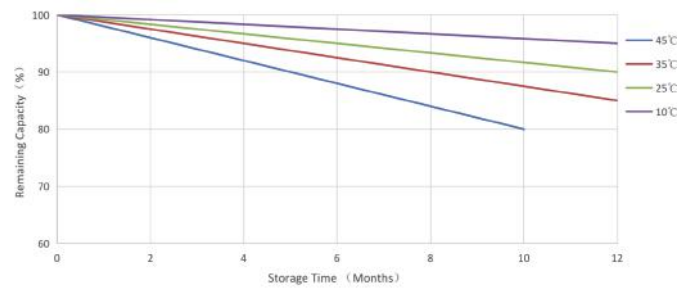

APP-Download

Please scan the QR code or click the link to download SolarV LFP App



iOS iOS

<https://apps.apple.com/de/app/solarv/id6444761417>



Android

<https://play.google.com/store/apps/details?id=com.aolarv.app&gl=DE>

Operation manual

1 Click on the App icon



2 Click „ADD NEW BATTERY“

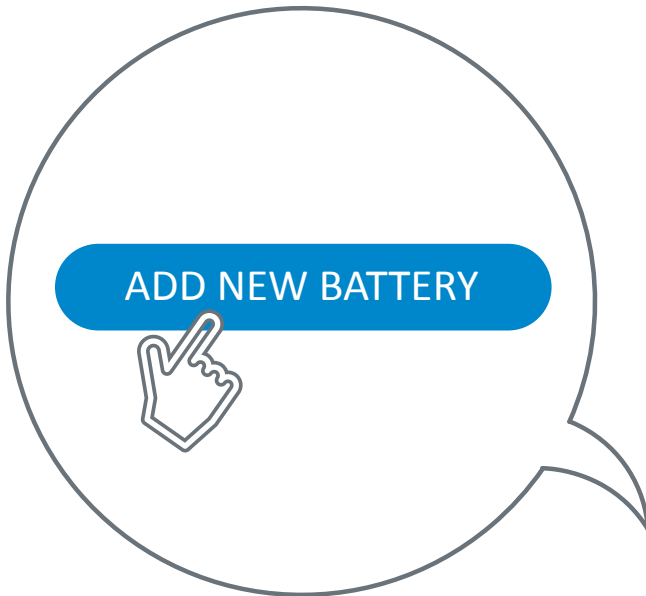

3 Turn on bluetooth

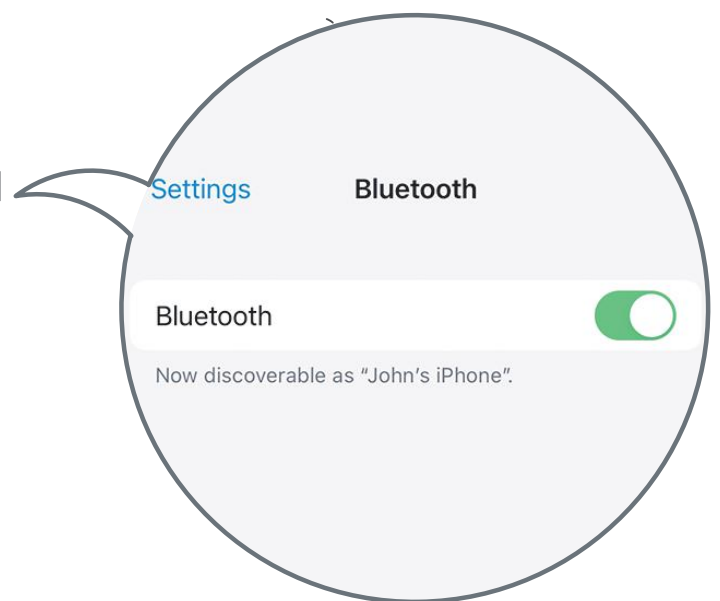

4 Search for your battery.
If it does not appear in the list, click on "Refresh"



5 Click on the Bluetooth name that is written on the battery.
You will now be taken to the home page of the app



Bluetooth-address:

6 Swipe the page to the left to display the basic information, protection status and protection statistics

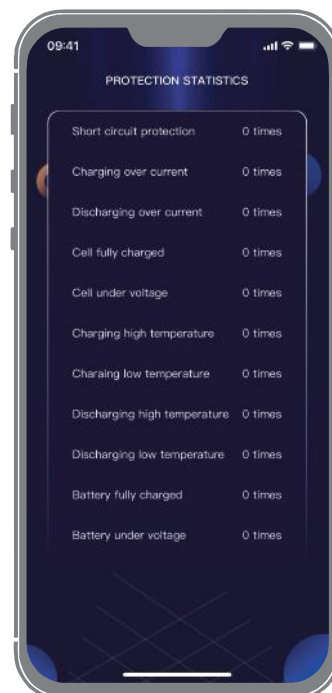
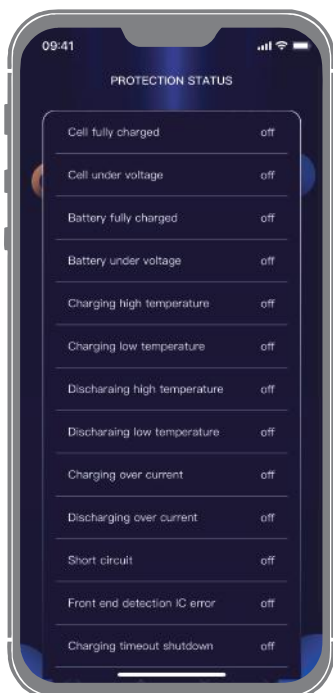
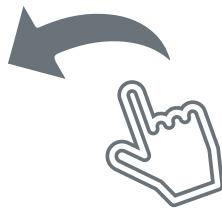
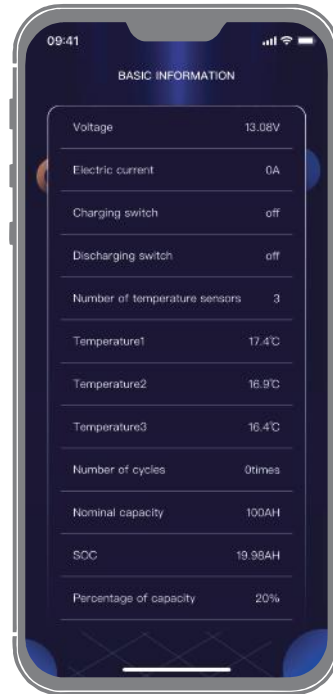

7 Click on the data behind the nominal capacity, enter the correct capacity in the pop-up field and click on „confirm" to complete the modification

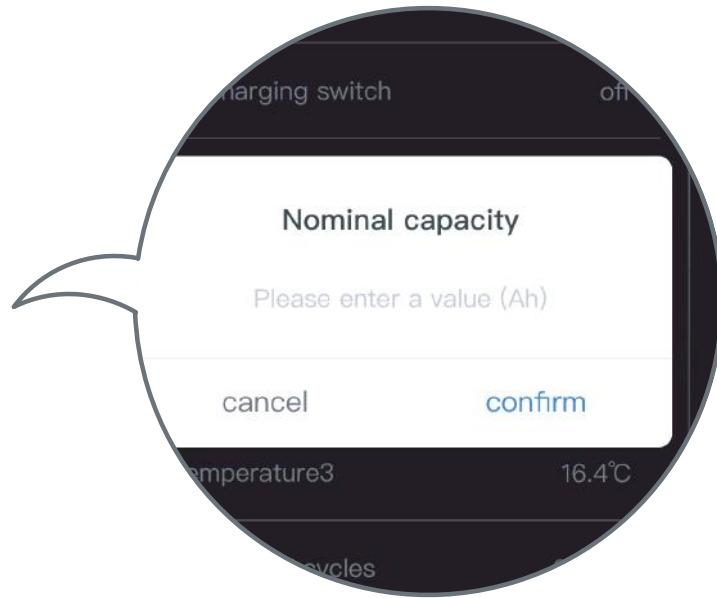
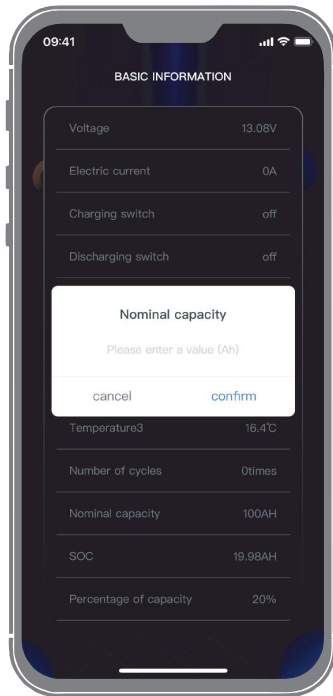

Troubleshooting

error display

troubleshooting

Cell fully charged on	Stop charging or discharge
Cell under voltage on	Charge the battery
Battery fully charged on	Stop charging or discharge
Battery under voltage on	Charge the battery
Charging high temperature on	Stop charging and move the battery to a shady area; the battery will automatically return to normal
Charging low temperature on	Stop charging and move the battery to a warmer (room) temperature environment; the battery will automatically return to normal
Discharging high temperature on	Stop discharging and move the battery to a shady area; the battery will automatically return to normal
Discharging low temperature on	Stop discharging and move the battery to a warmer (room) temperature environment; the battery will automatically return to normal
Charging over current on	Stop charging and check the charger output current.
Discharging over current on	Stop discharging and make sure the load current is not within the battery maximum discharge current range
Short circuit on	Fix the short circuit error. If the error cannot be cleared automatically, charge the battery to clear the error. If this is not possible, send the battery to the workshop for repair
Front end detection IC error	Depot repair
Charging timeout shutdown	Depot repair



power your life



SolarV GmbH
info@solarv.de
www.solarv.de