

# ERKLÄRUNG:

1. FOX ESS HAT UNSERE NEUE GENERATION DES V2.0-BATTERIESYSTEMS OFFIZIELL GESTARTET
2. UM IHNEN ZU HELFEN, SICH MIT DER INSTALLATION DES NEUEN BATTERIESYSTEMS VERTRAUT ZU MACHEN, PRÄSENTIERT IHNEN FOX EINE UMFASSENDE EINFÜHRUNG IN DEN AUFKLEBER UND SEINE KOMPATIBILITÄTSRICHTLINIEN.

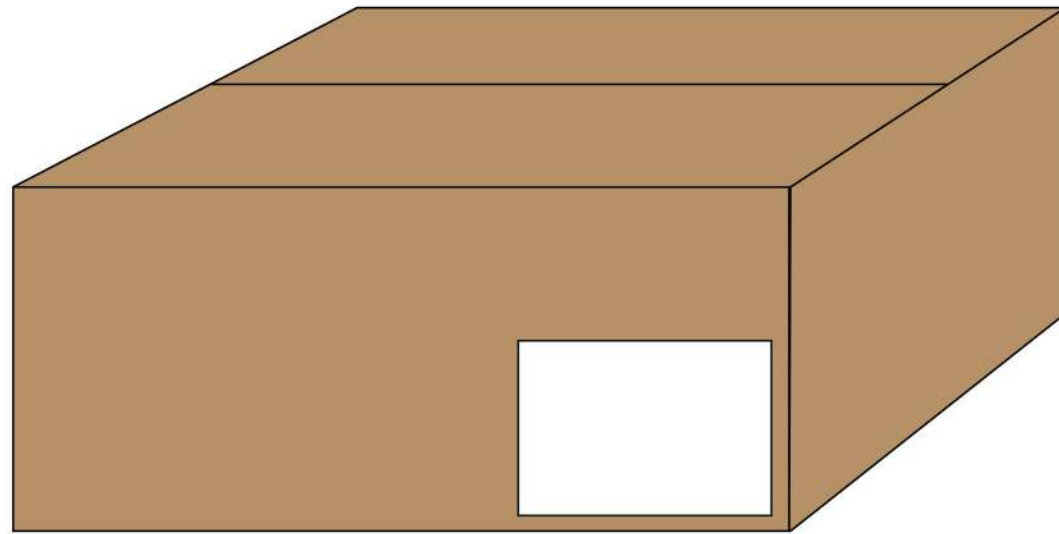

V1.0 BATTERIE / BMS

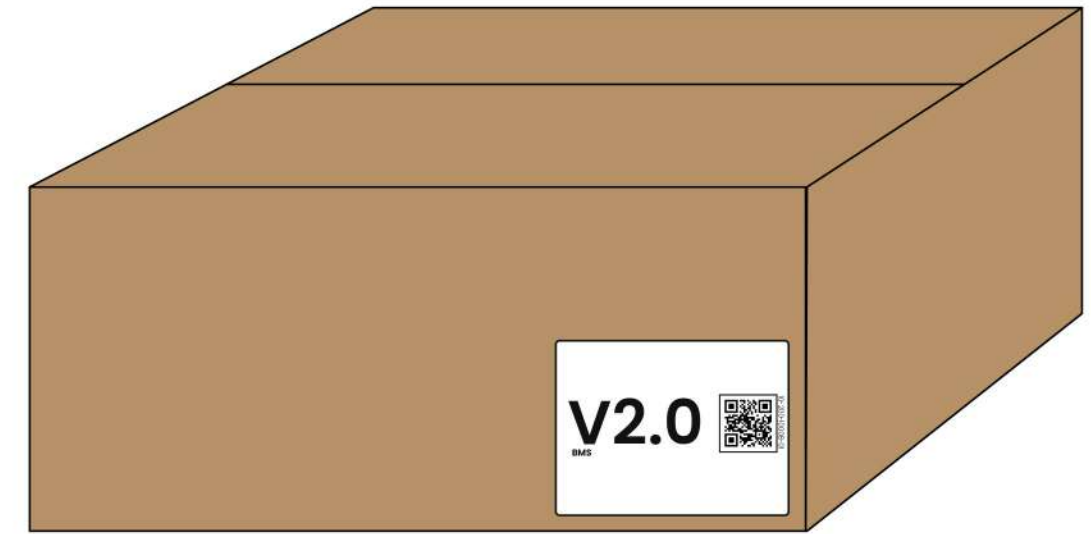
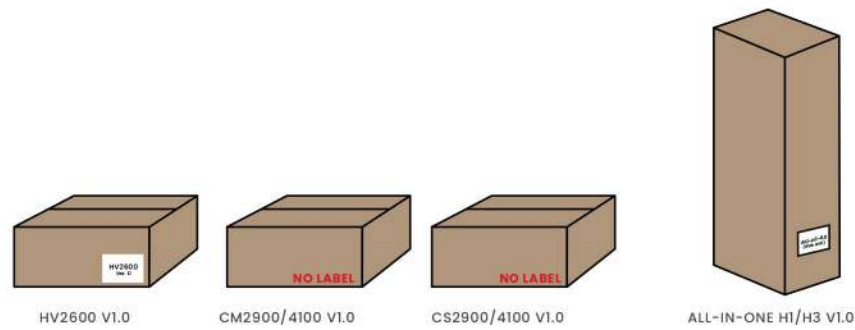

V2.0 BATTERIE / BMS

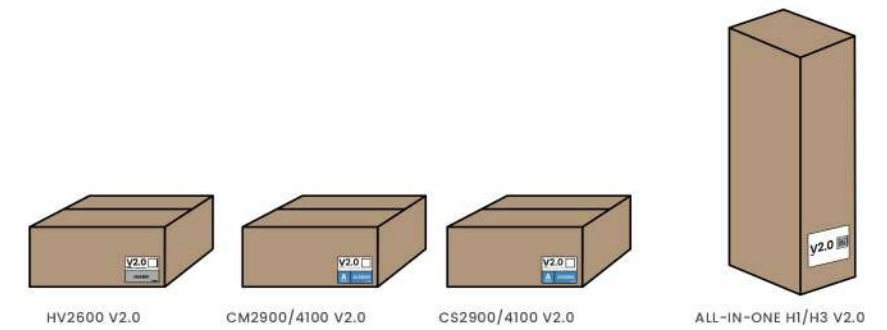

ACHTUNG: WENN KEIN V2.0-ETIKETT IST, IST ES V1.0

# BMS-UND BATTERIE-ZUSAMMEN PASSUNGSREGELN

**BMS V1.0** → **BATTERIE V1.0**

**BMS V2.0** → **BATTERIE V1.0**  
**BMS V2.0** → **BATTERIE V2.0**



**BMS V1.0** → ~~→~~ **BATTERIE V2.0**

# BEISPIEL:

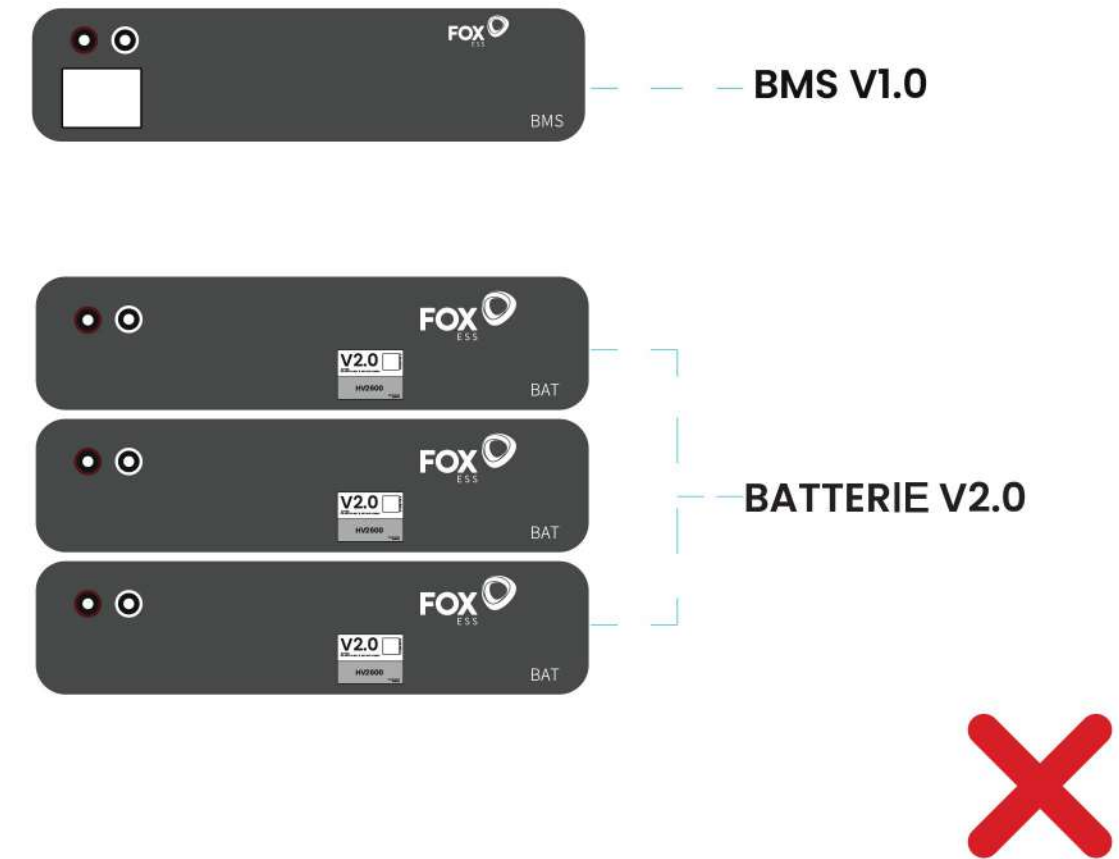
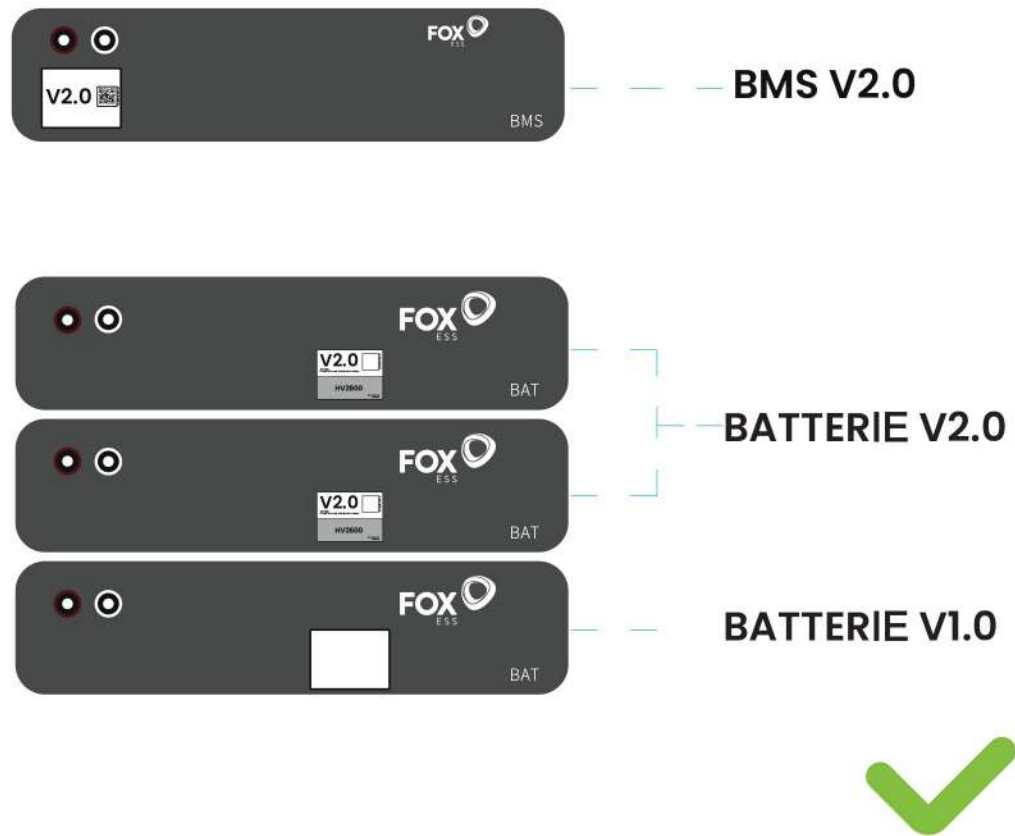
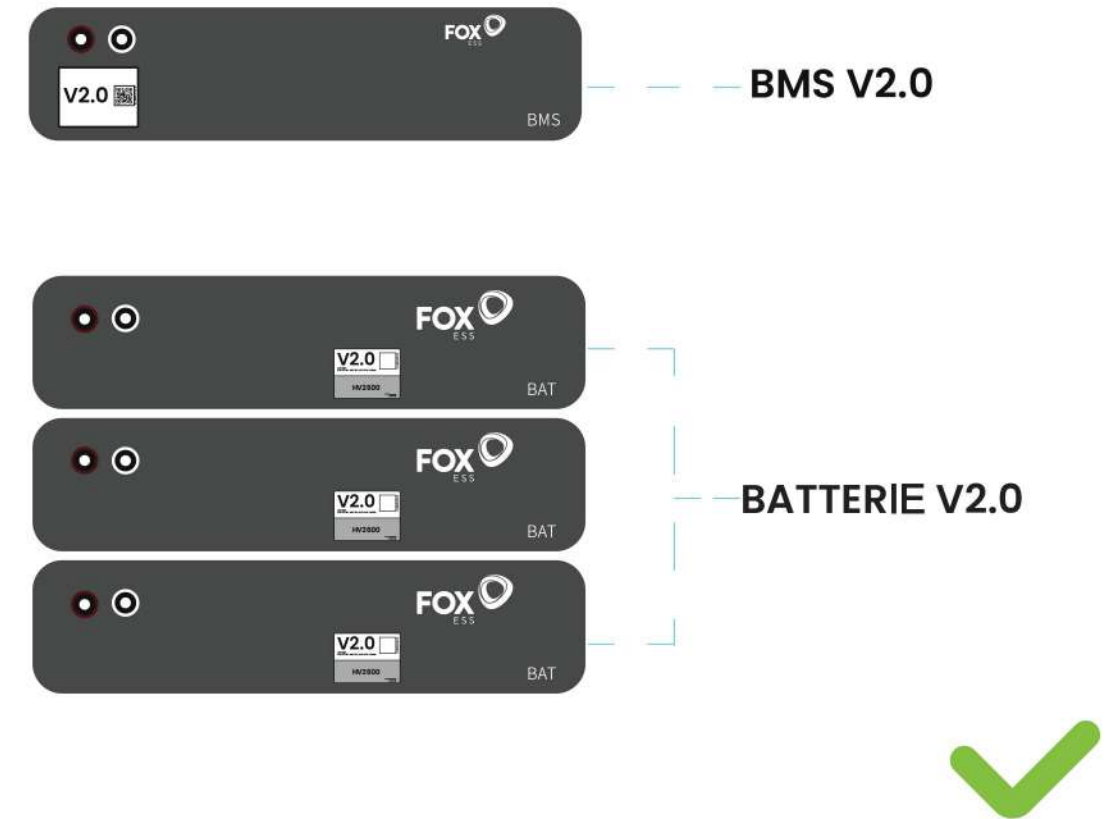
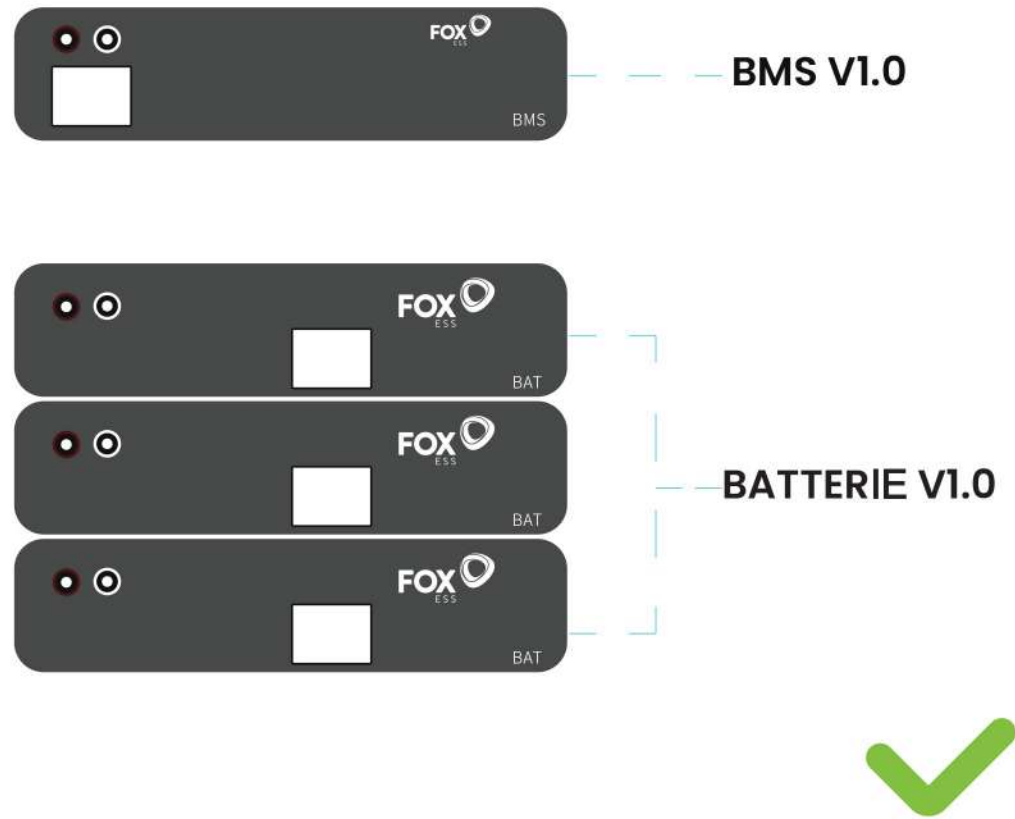

# BEISPIEL:

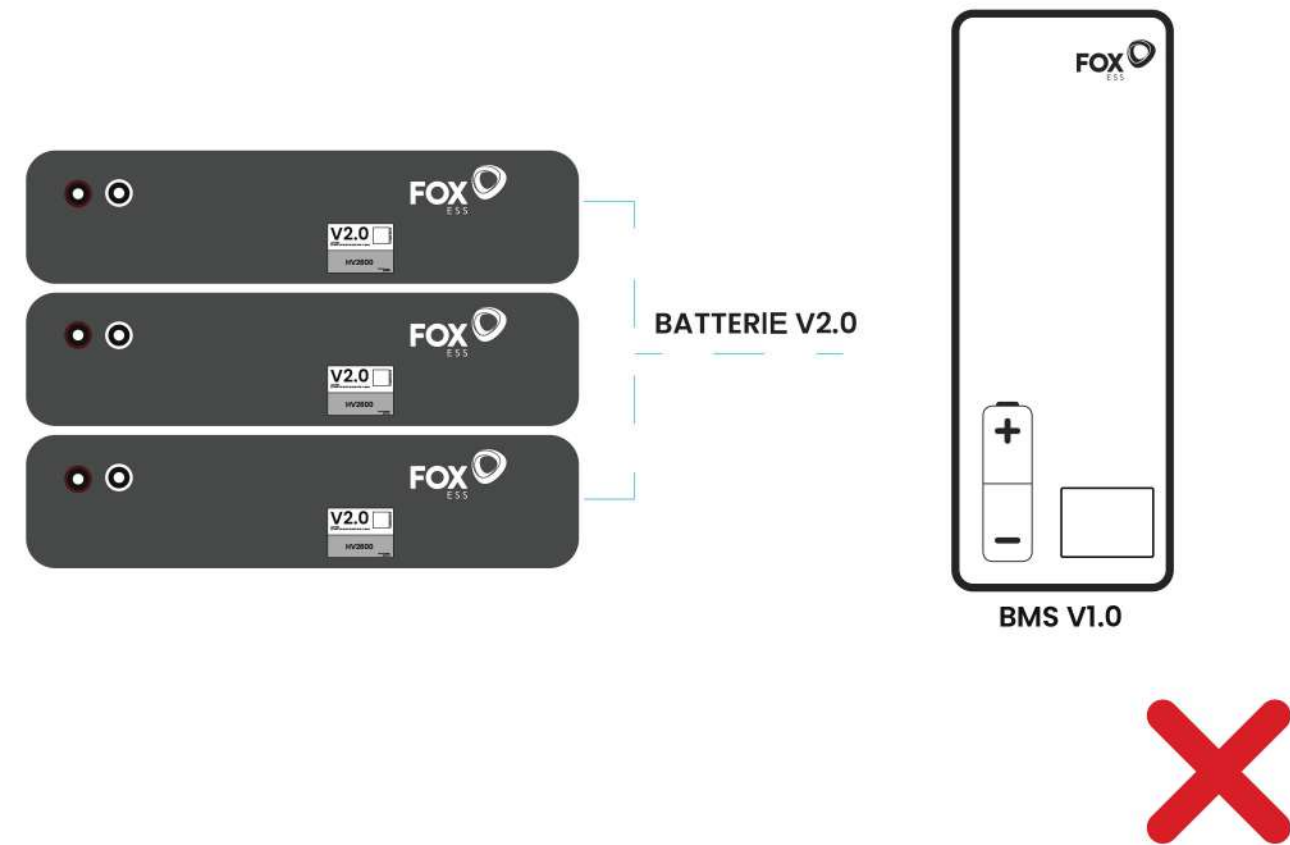
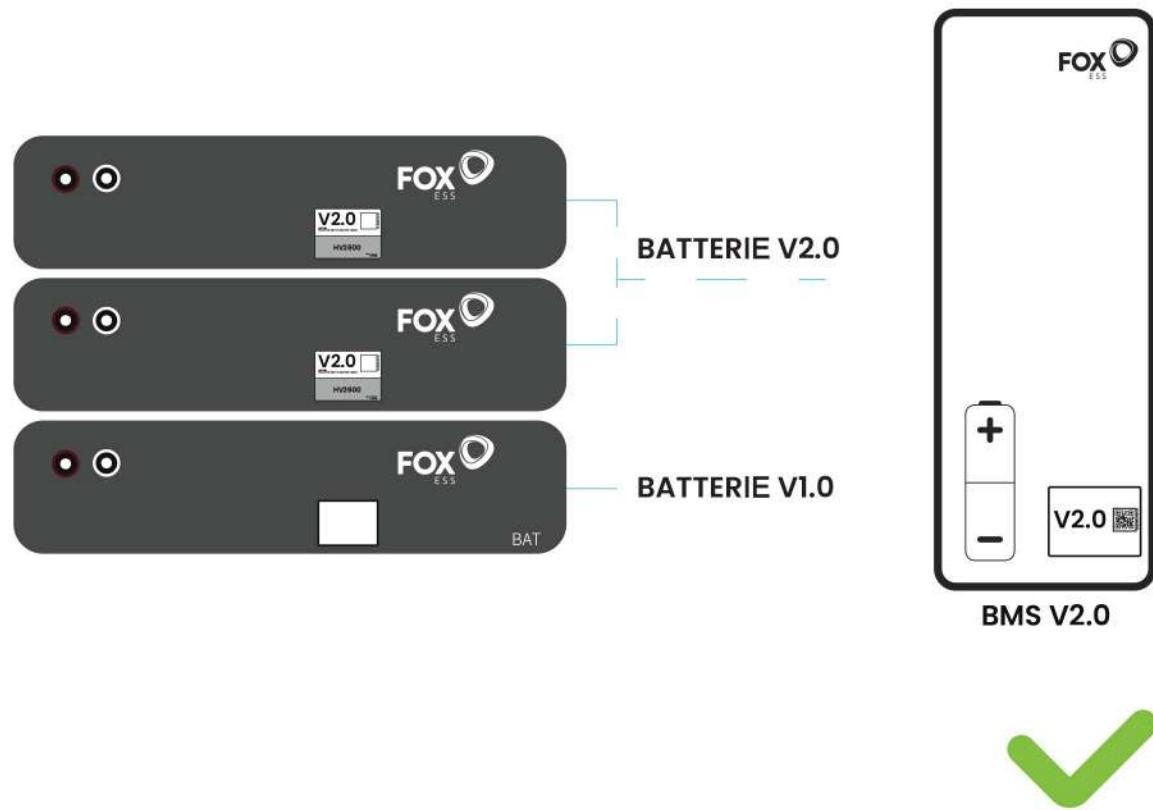
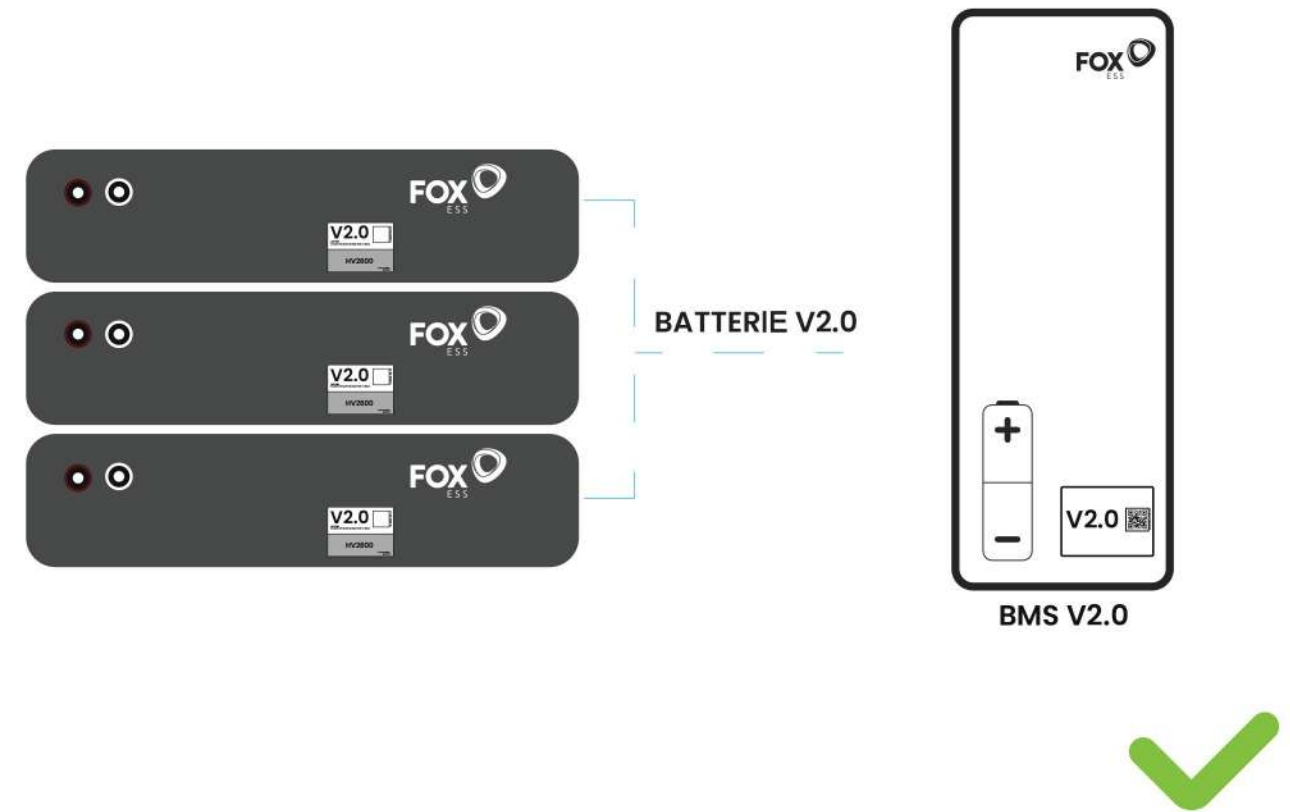
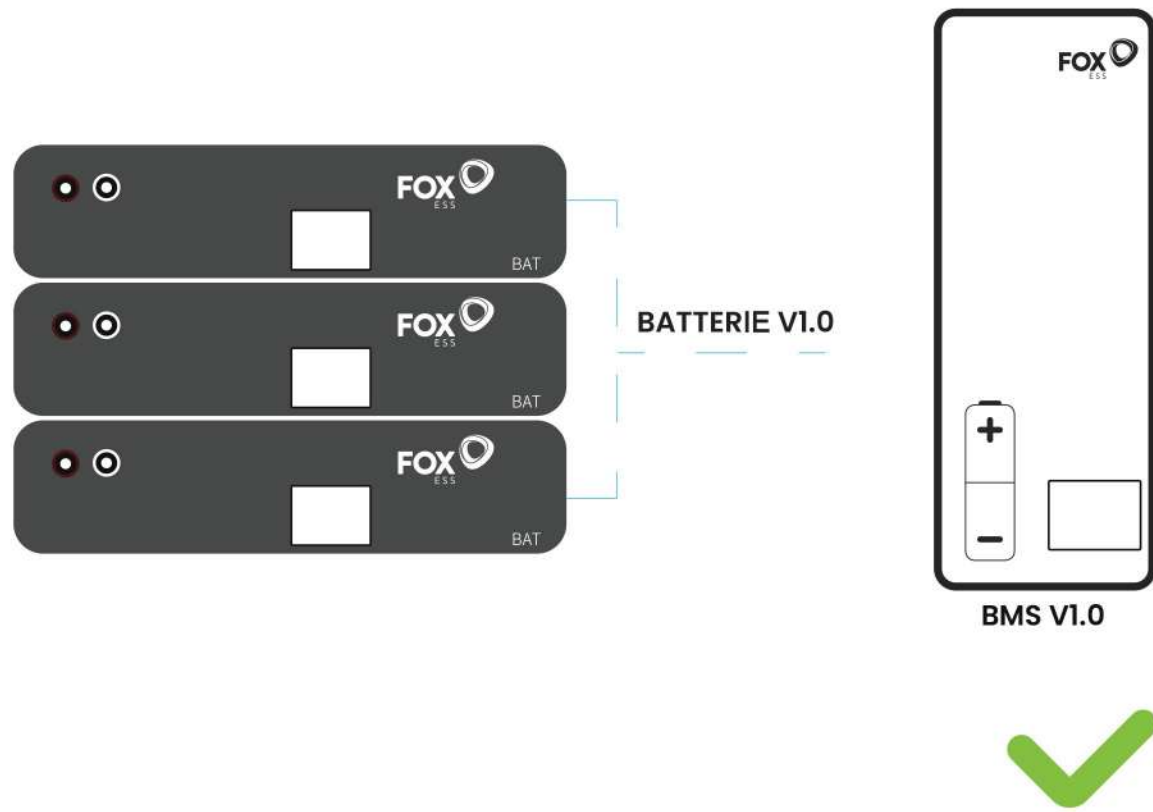

# BEISPIEL:

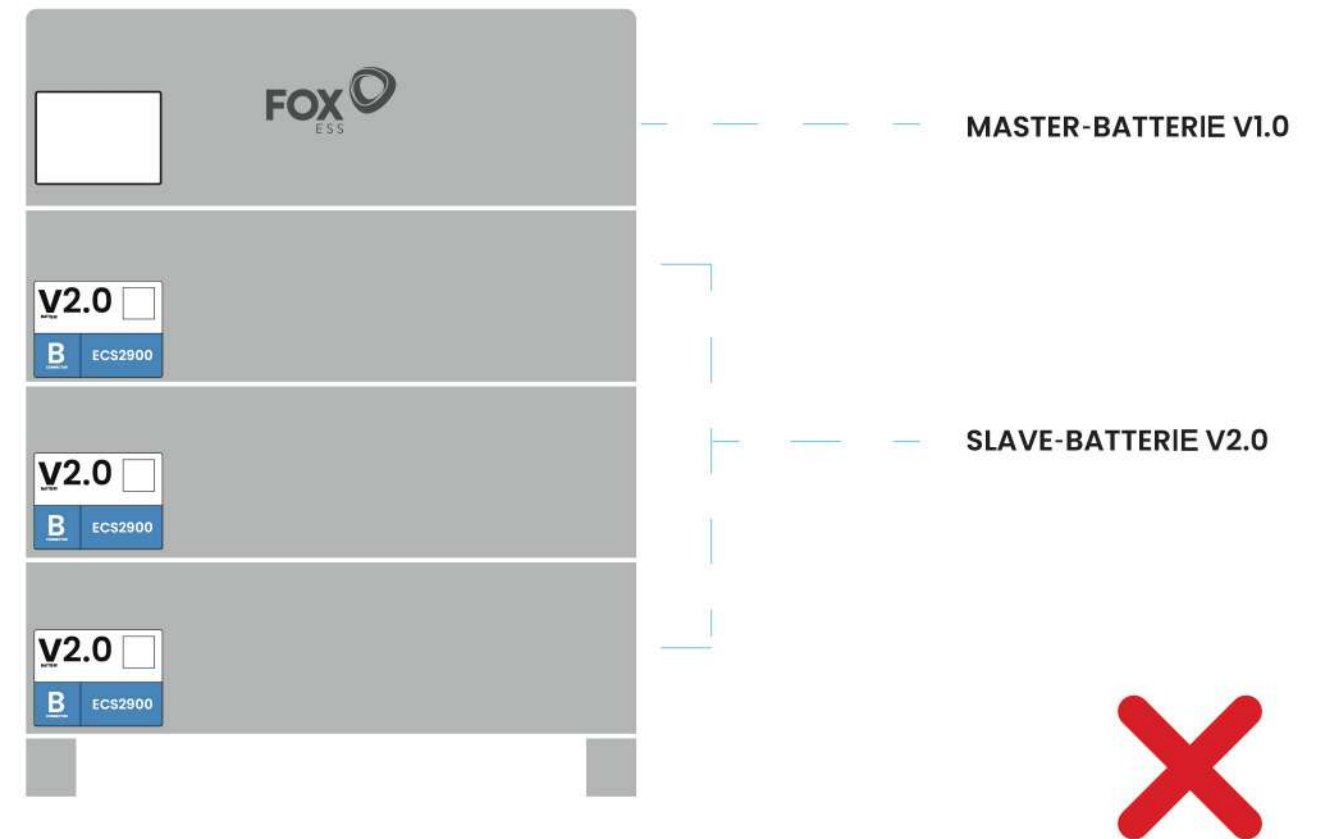
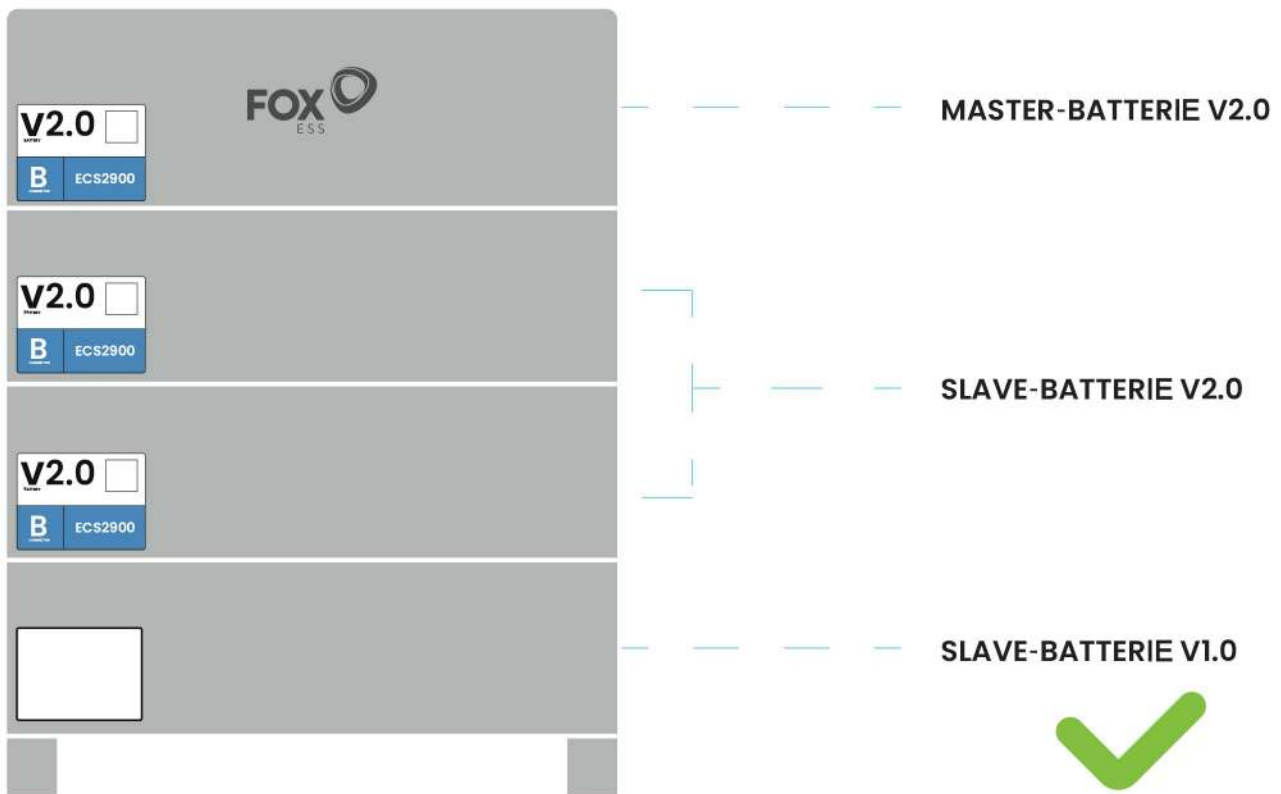
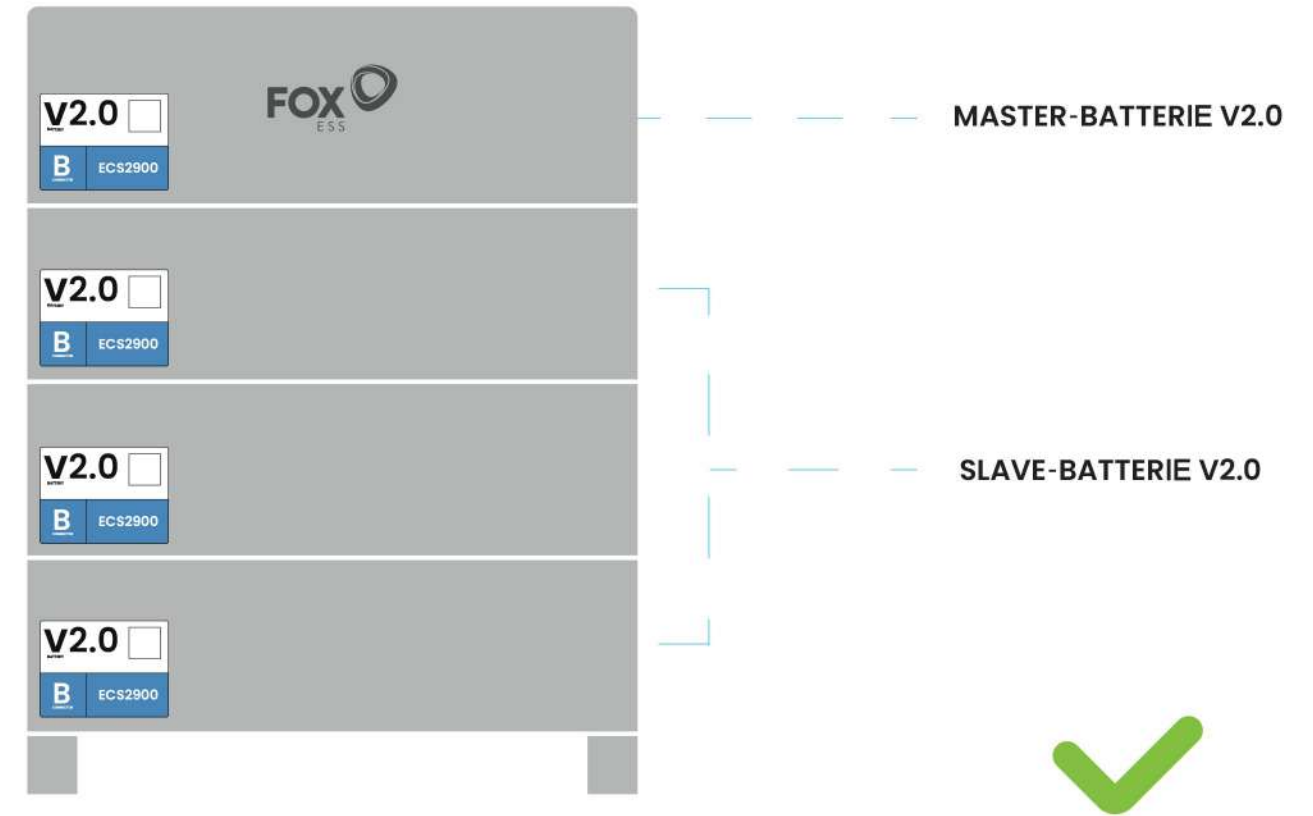
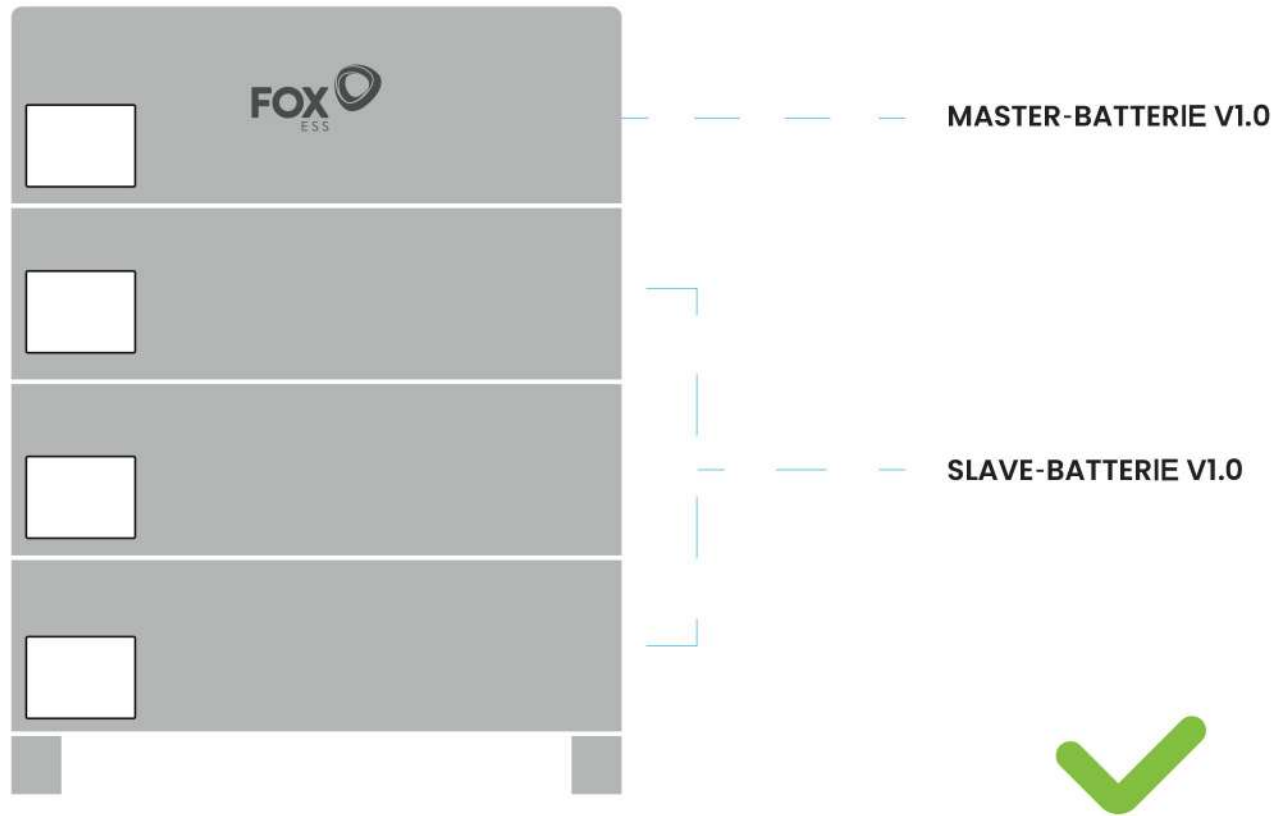

NUR FÜR ENERGY CUBE

ES GIBT ZWEI ARTEN VON ANSCHLÜSSEN: A&B  
SIE KÖNNEN NICHT GEMISCHT VERWENDET WERDEN



---

A Anschlussbatterie



A Anschlussbatterie

B Anschlussbatterie



B Anschlussbatterie

A Anschlussbatterie



B Anschlussbatterie

# BEISPIEL:

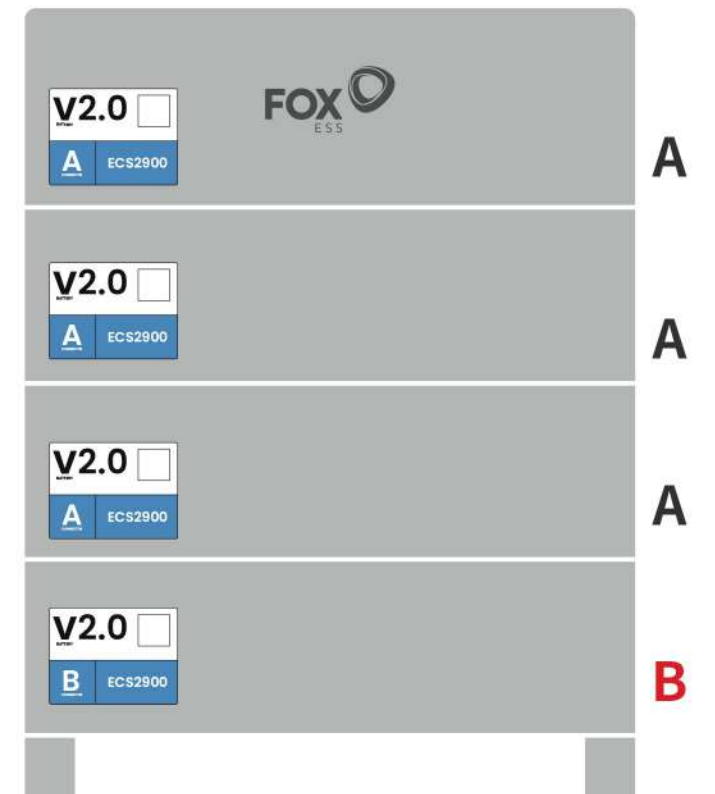
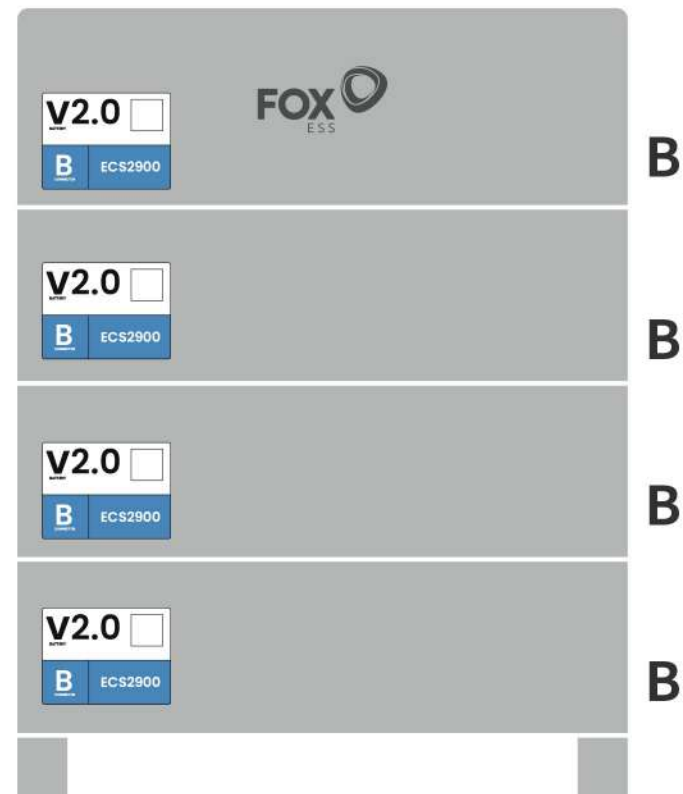
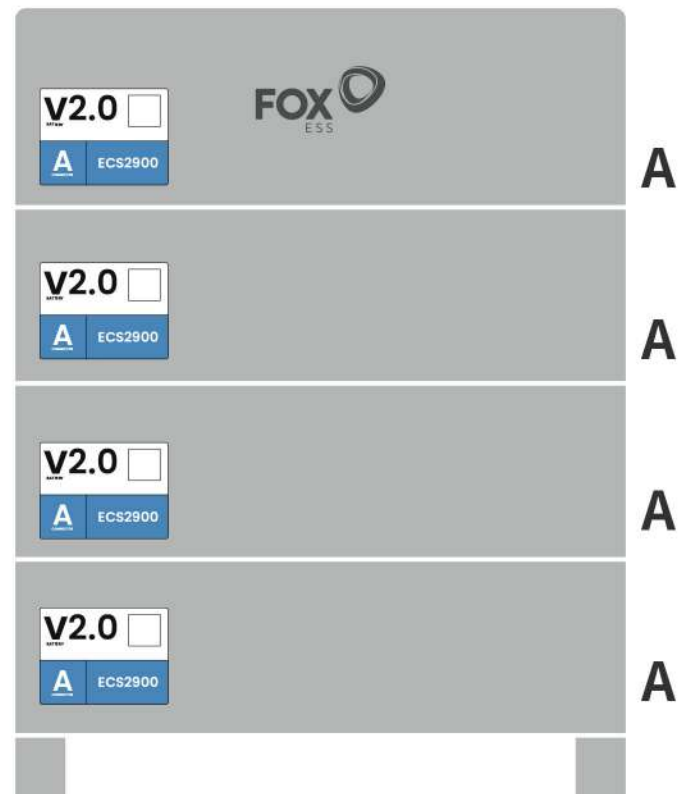

# UM DIE HÖCHSTE LEISTUNG ZU ERREICHEN, WIRD ES EMPFOHLEN UM DIE SELBEN FARBZELLEN IN EINER SERIE ZU VERWENDEN

**V2.0**

BATTERIE

**A**  
CONNECTOR

**ECS2900**

**V2.0**

BATTERIE

**A**  
CONNECTOR

**ECS2900**

**V2.0**

BATTERIE

**HV2600**

**V2.0**

BATTERIE  
V2.0-BATTERIE MUSS MIT V2.0BMS VERWENDET WERDEN

**A**  
CONNECTOR  
B CONNECTOR BATTERY MUST BE USED WITH ANOTHER B CONNECTOR BATTERY

**ECS4100**  
GREEN COLOUR (CODE 4)

**V2.0**

BATTERIE  
V2.0-BATTERIE MUSS MIT V2.0BMS VERWENDET WERDEN

**MIRA HV25**



# BEISPIEL:



**NICHT  
EMPFOHLEN**



**NICHT  
EMPFOHLEN**