

# STATEMENT:

- 1. FOX ESS HAS OFFICIALLY LAUNCHED OUR NEW GENERATION OF V2.0 BATTERY SYSTEM
- 2. IN ORDER TO HELP YOU FAMILIARIZE YOURSELF WITH NEW BATTERY SYSTEM INSTALLATION, FOX WILL PRESENT A COMPREHENSIVE INTRODUCTION ON THE STICKER AND ITS COMPATIBILITY GUIDELINES.

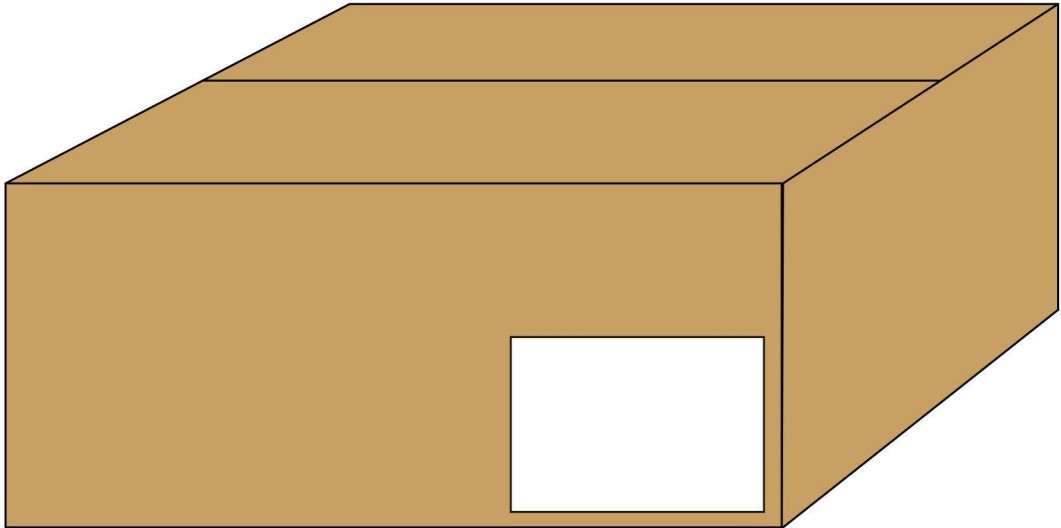

V1.0 BATTERY / BMS

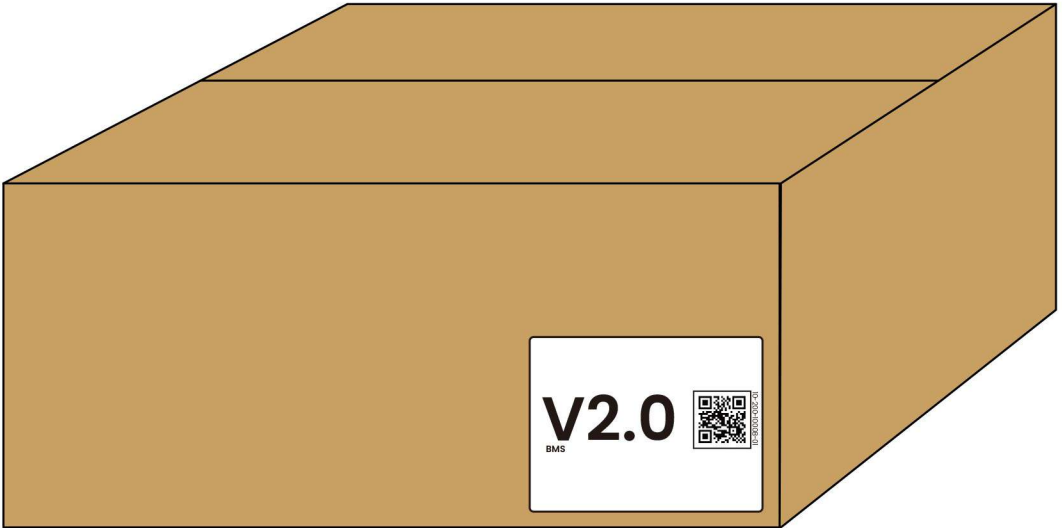

V2.0 BATTERY / BMS

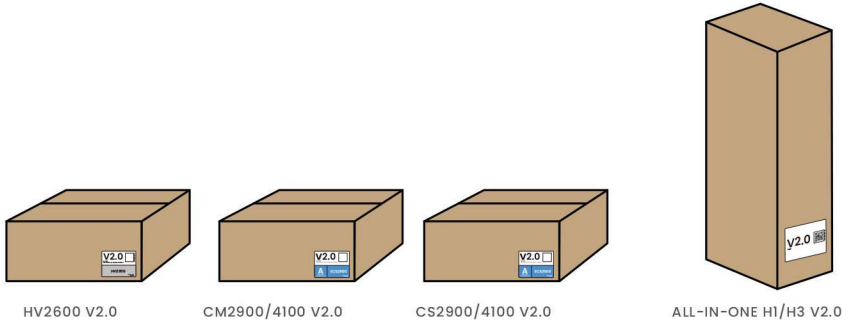
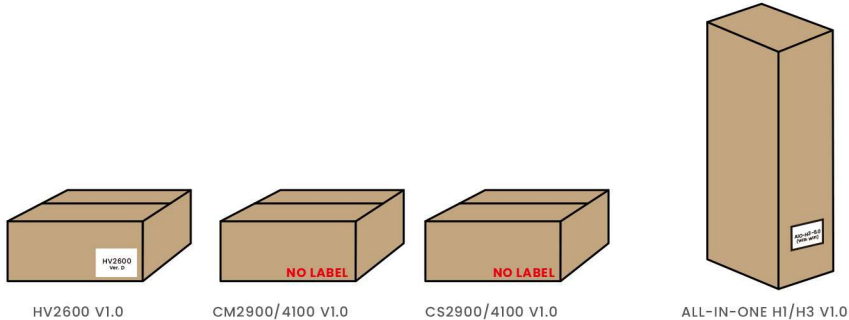

ATTENTION: IF NO V2.0 LABEL, IT IS V1.0

# BMS AND BATTERY MATCHING RULES

**BMS V1.0** → **BATTERY V1.0**

**BMS V2.0** → **BATTERY V1.0**  
**BMS V2.0** → **BATTERY V2.0**



**BMS V1.0** → ~~→~~ **BATTERY V2.0**

# EXAMPLE:

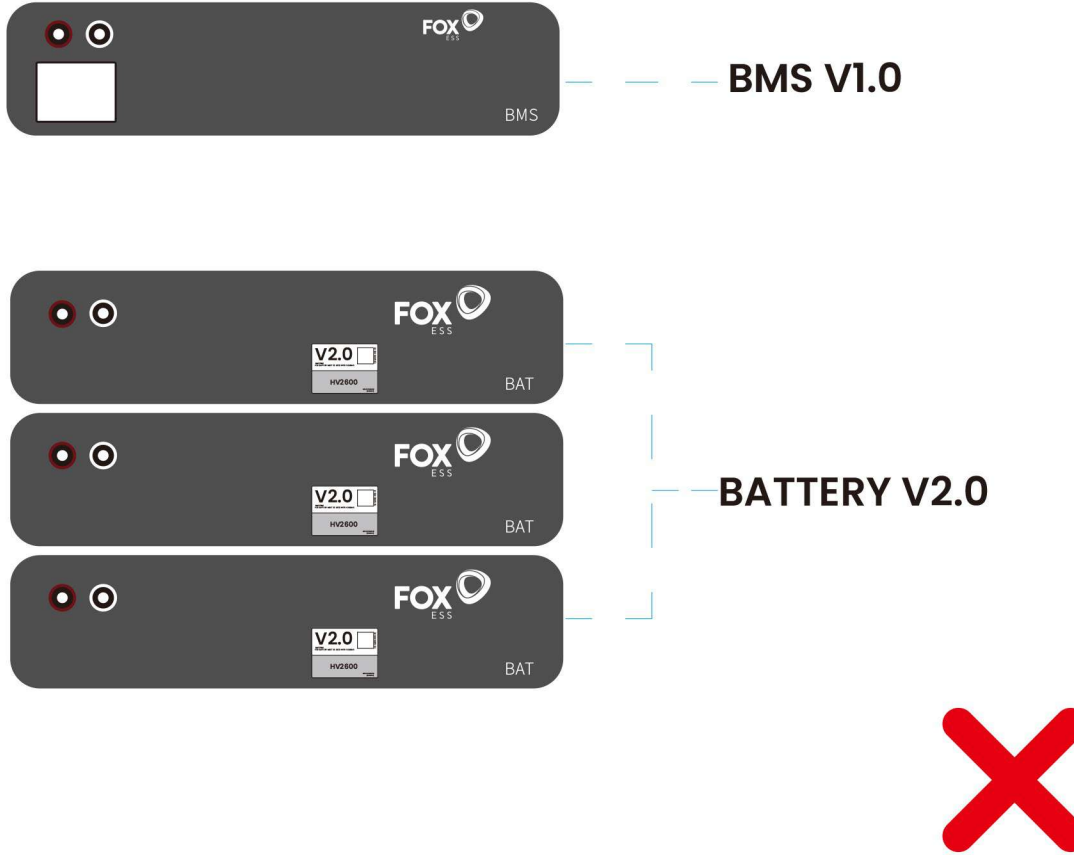
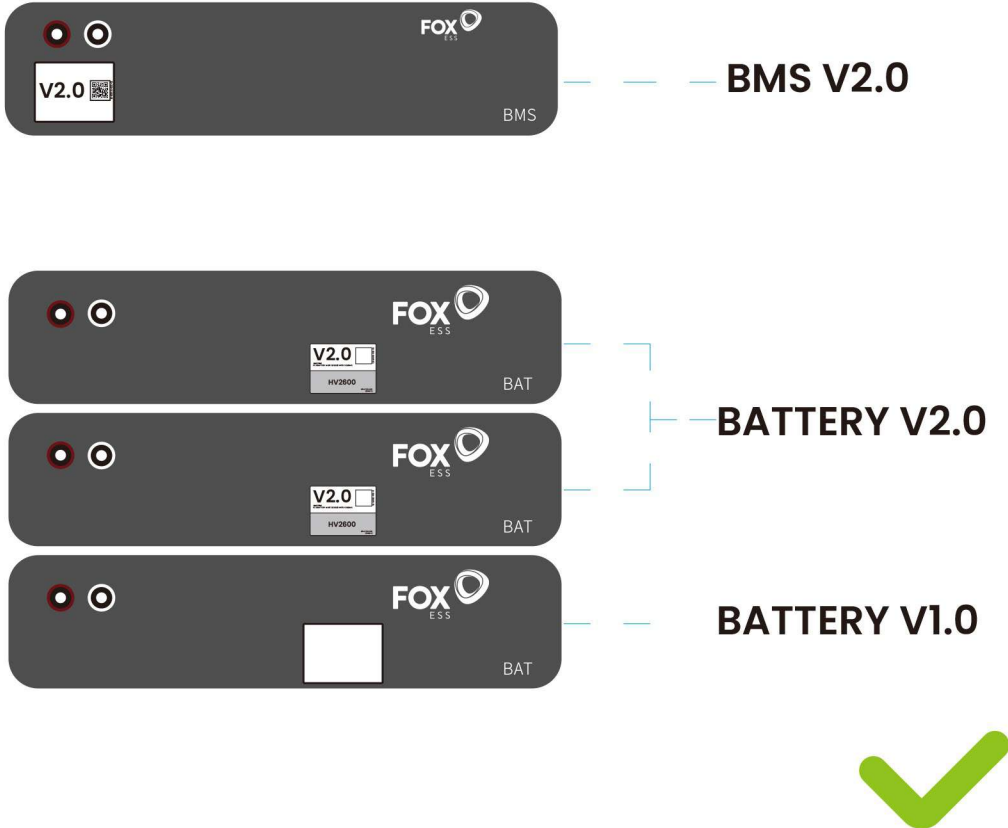
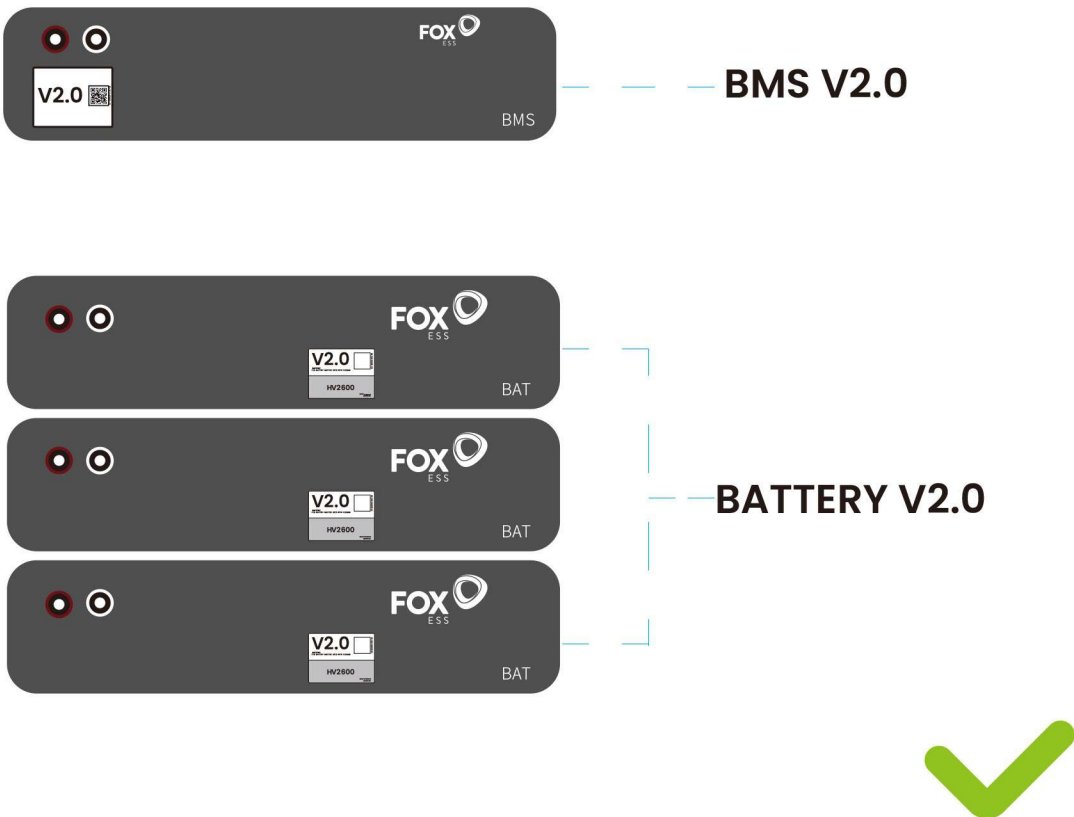
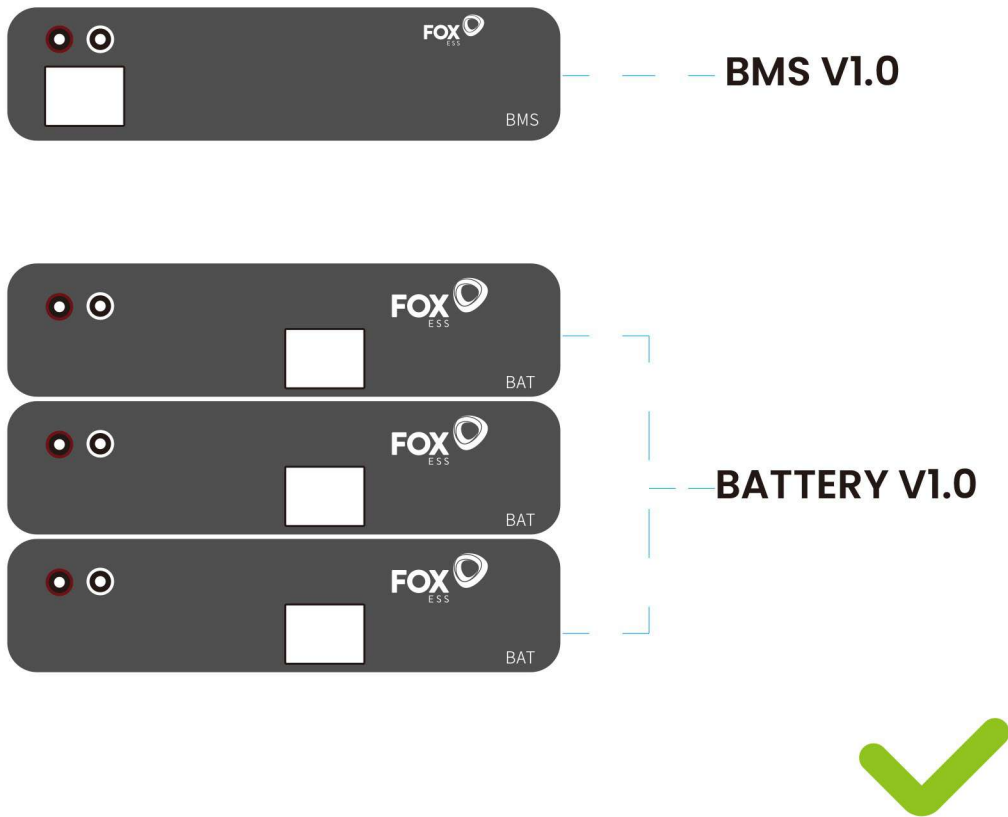

# EXAMPLE:

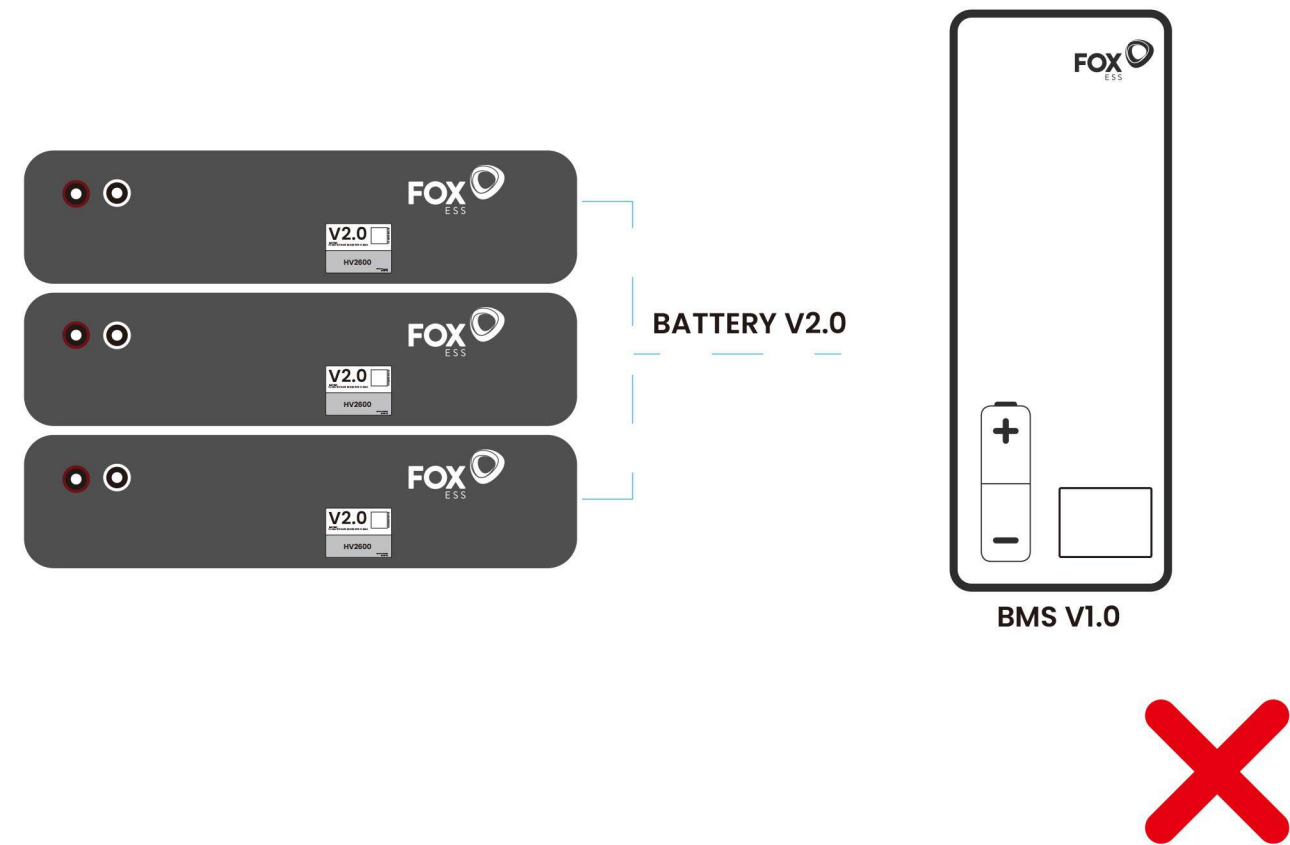
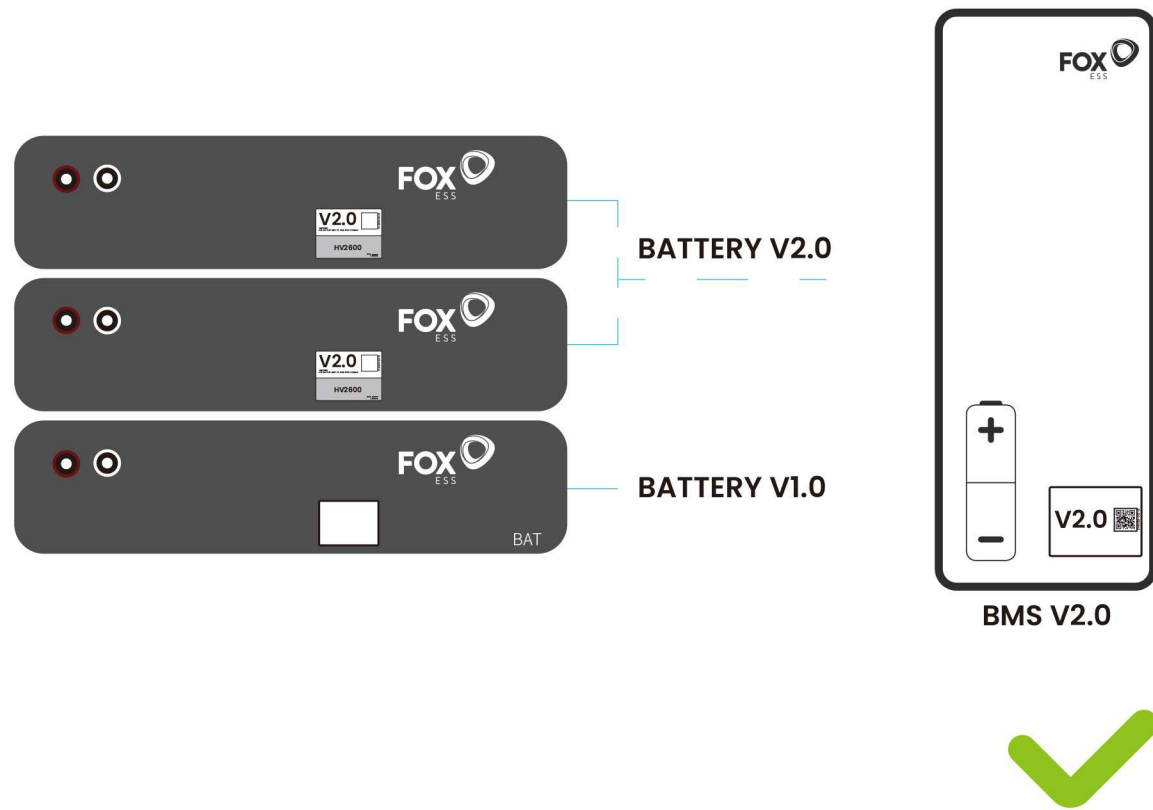
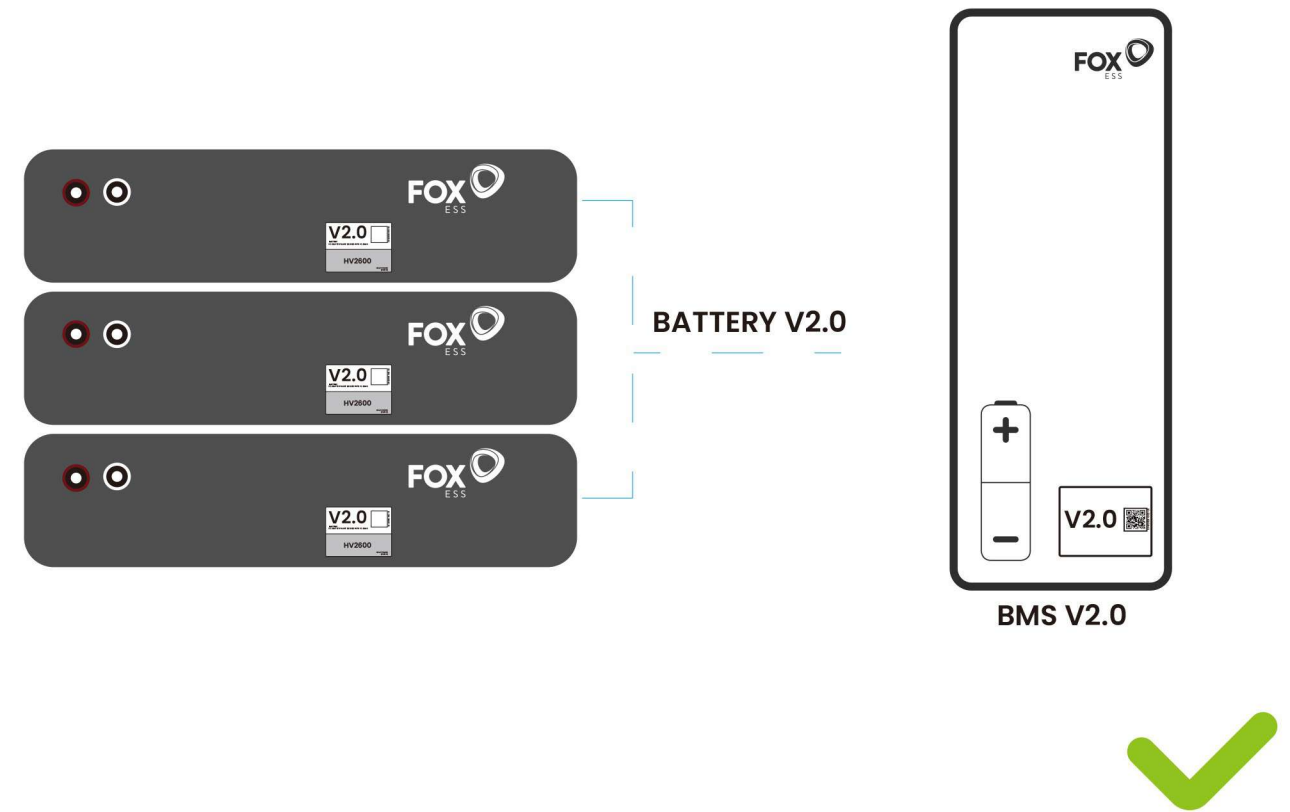
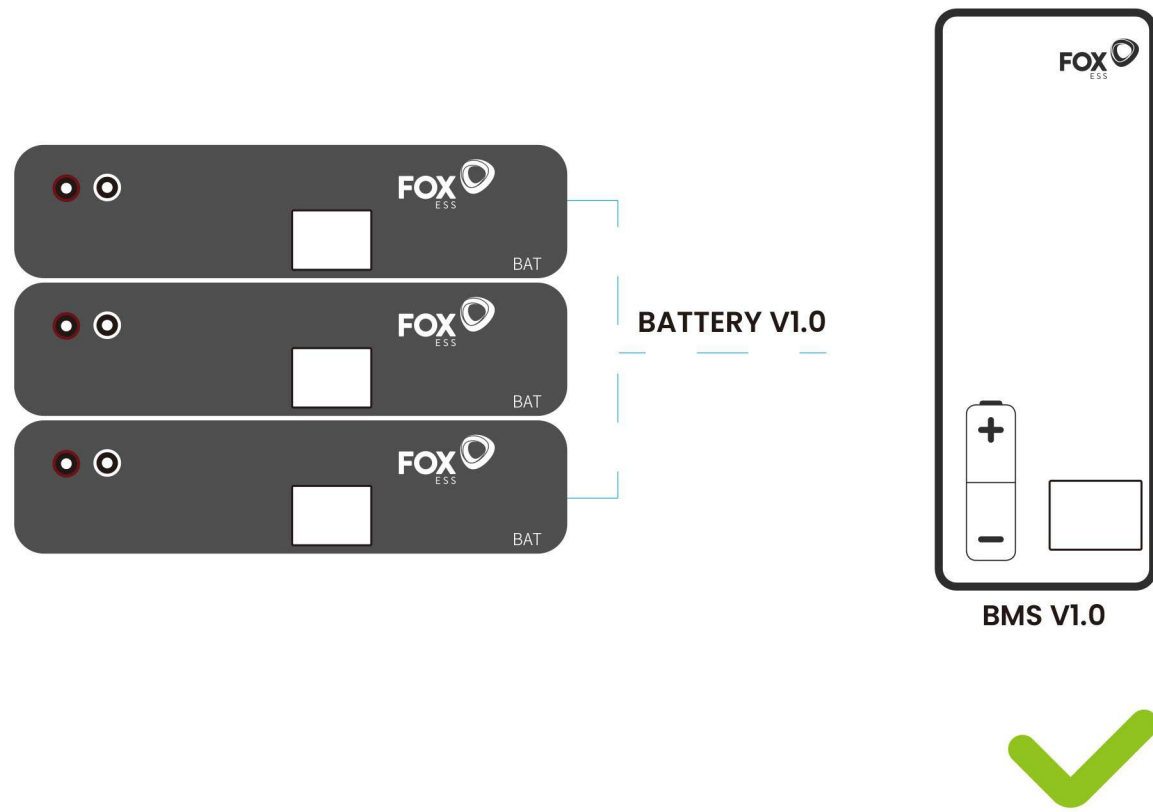

# EXAMPLE:

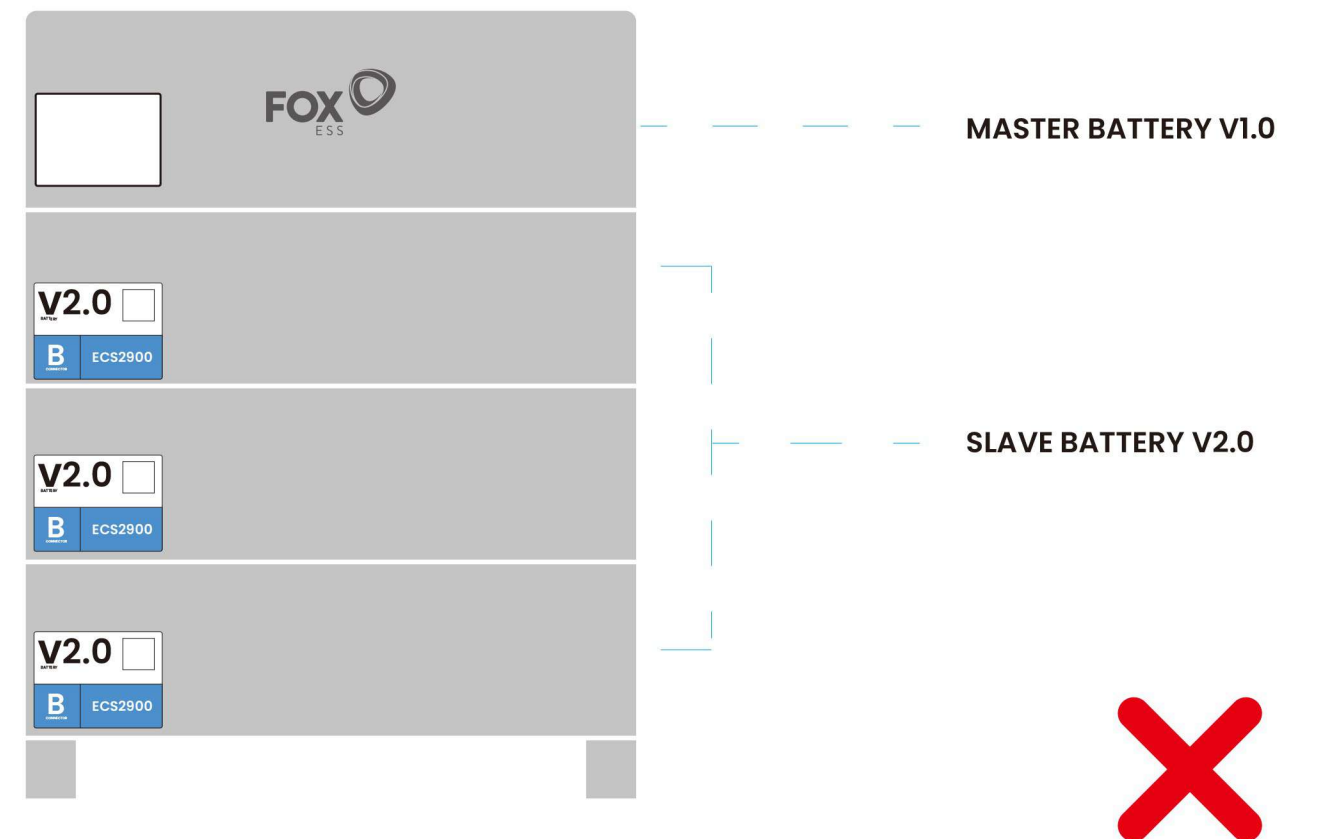
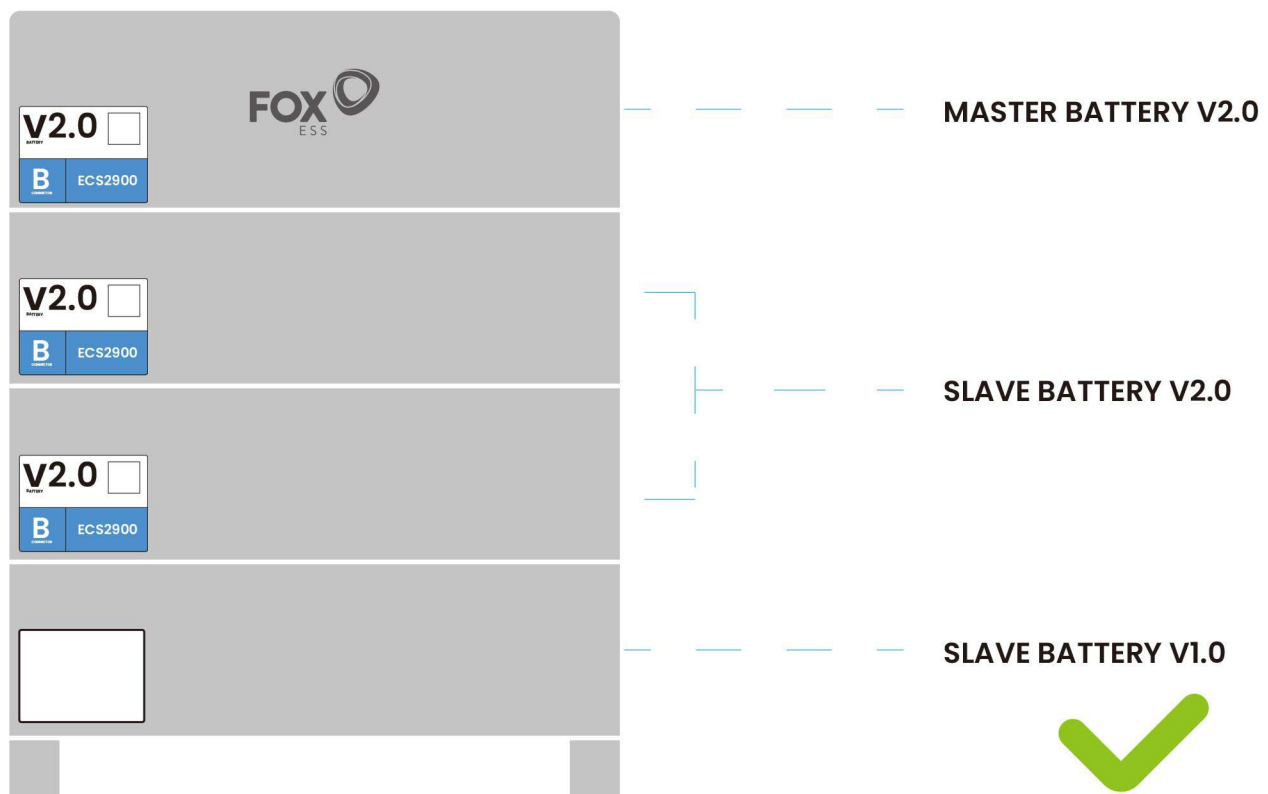
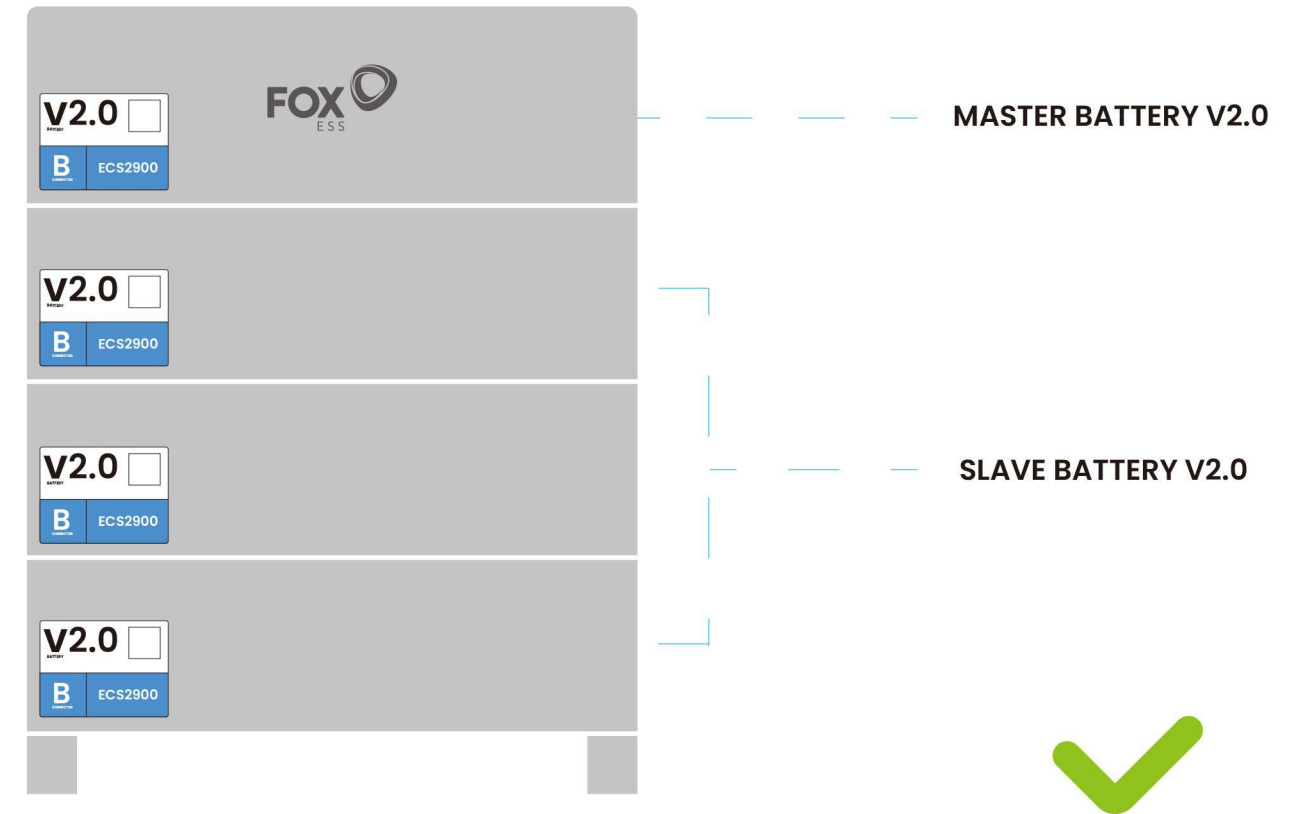
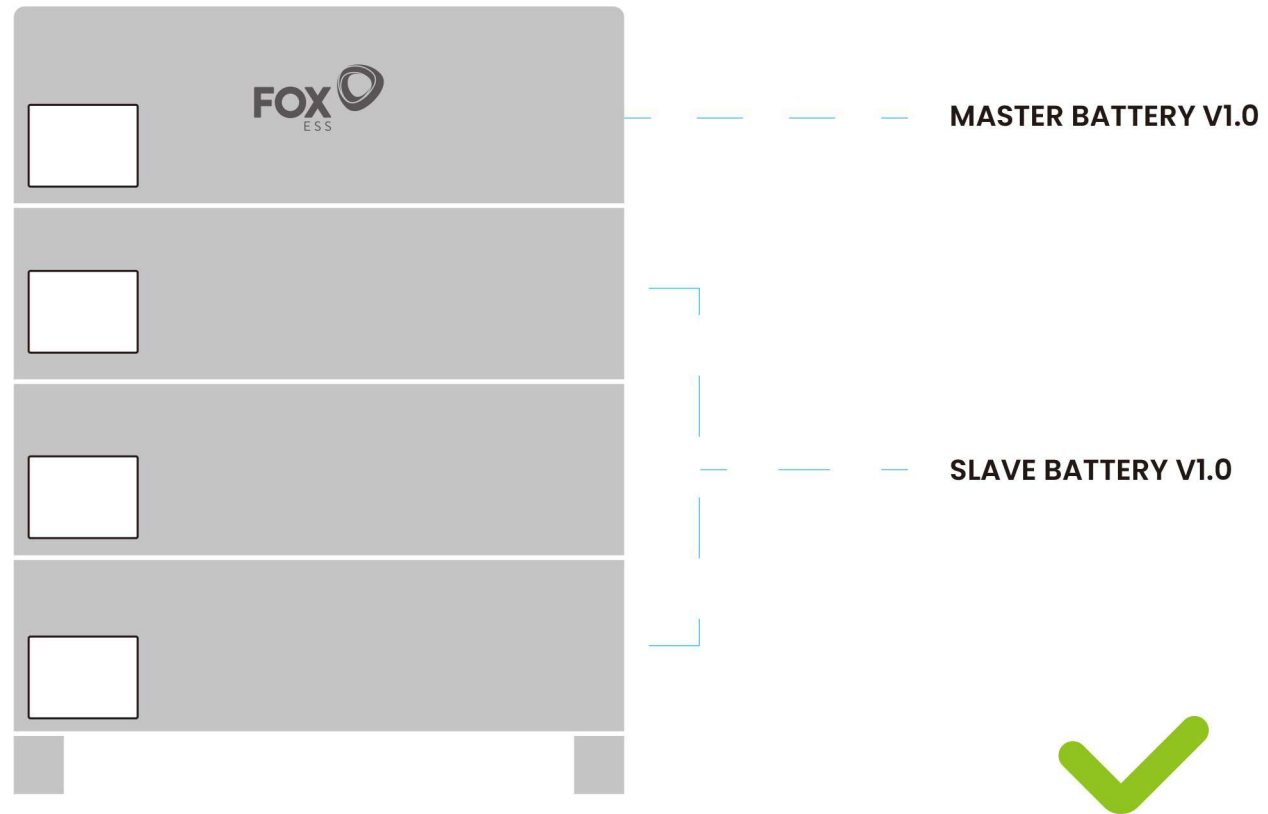

ONLY FOR ENERGY CUBE

# THERE ARE TWO TYPES OF CONNECTORS: A&B THEY CANNOT BE MIXED-USED

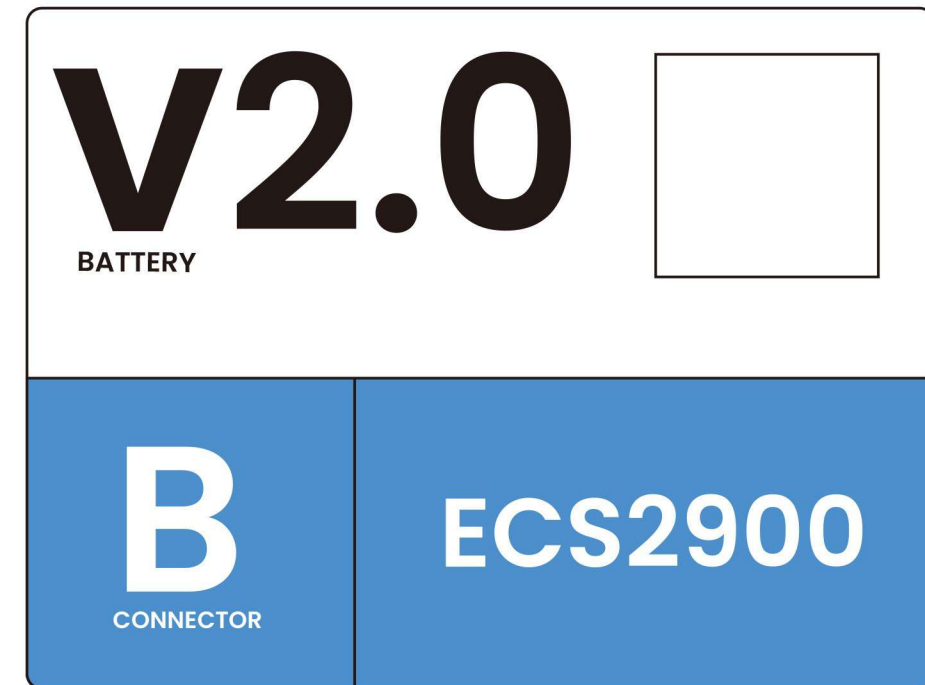
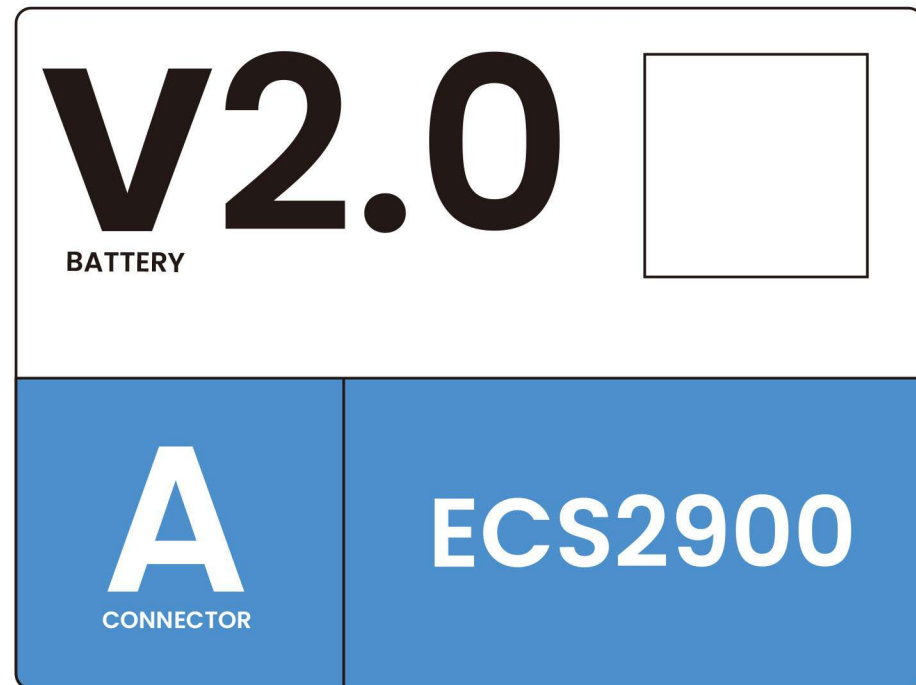

---

A Connector battery → A Connector battery

B Connector battery → B Connector battery

A Connector battery ~~→~~ B Connector battery

# EXAMPLE:

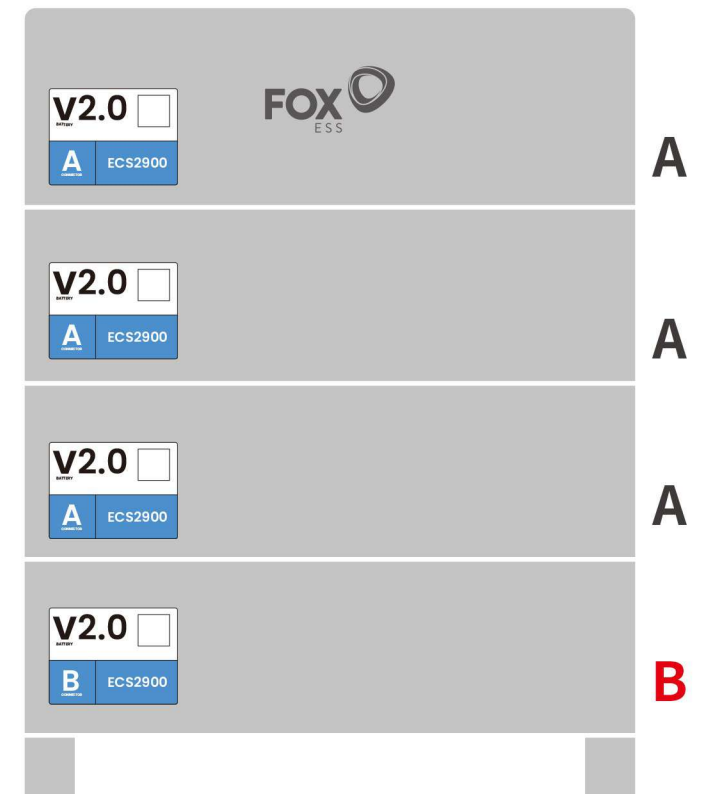

# TO REACH THE HIGHEST PERFORMANCE, IT IS RECOMMENDED TO USE THE SAME COLOUR CELLS IN ONE SERIE

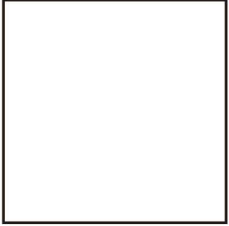
**V2.0**   
BATTERY

**A**  
CONNECTOR

**ECS2900**

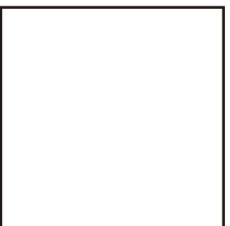
**V2.0**   
BATTERY

**A**  
CONNECTOR

**ECS2900**

**V2.0**   
BATTERY

**HV2600**

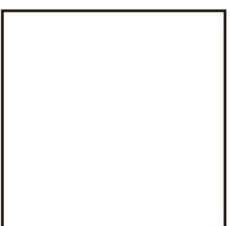
**V2.0**   
BATTERY  
V2.0 BATTERY MUST BE USED WITH V2.0BMS

**A**  
CONNECTOR  
B CONNECTOR BATTERY MUST BE USED WITH ANOTHER B CONNECTOR BATTERY

**ECS4100**  
GREEN COLOUR  
(CODE 4)

**V2.0**   
BATTERY  
V2.0 BATTERY MUST BE USED WITH V2.0BMS

**MIRA HV25**



# EXAMPLE:

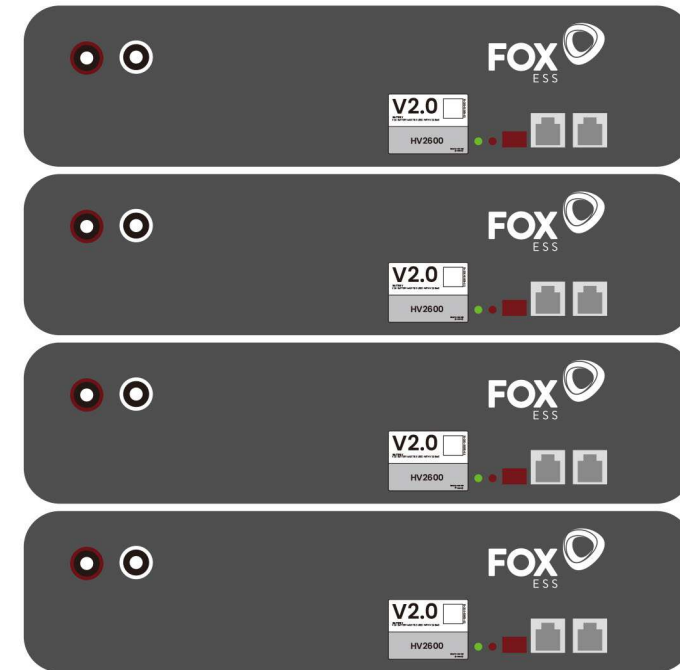

**NOT  
RECOMMENDED**



**NOT  
RECOMMENDED**