

### ▶ Product Appearance

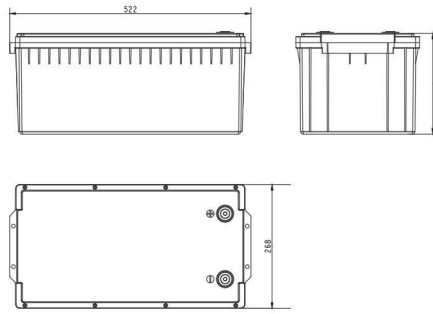

### ▶ Product Size



Net Weight: 17.9±0.5kg

### ▶ Packaging Size

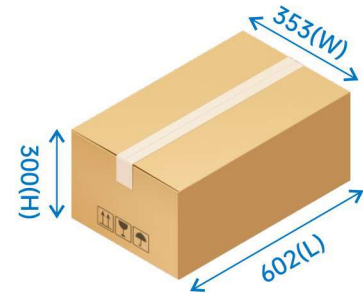

Gross Weight: 19.5±0.5kg

### ▶ Features

- A grade brand new prismatic LiFePO<sub>4</sub> cells
- Cell balance function
- ≥4000 cycles @80% DOD(25°C, 0.5C )
- IP65 superior safety
- Over charge, over discharge, over temperature, low temperature, over current and short circuit protection
- Certificate: UN38.3, MSDS, IEC62619、CE-RED、ROHS
- Easy installation and maintenance free
- Supports series and parallel connection
- Charging Heating Technique
- Supports Bluetooth communication

### ▶ Technical Specifications

Model	LFP1.92KWH12.8V-P65L2TN40
Battery Type	LiFePO <sub>4</sub>
Nominal Voltage (V)	12.8
Nominal Capacity (AH)	150
Energy (WH)	1920
Pack Mode	4S1P
Continuous Discharge Current (A)	100
Charge Cut-off Voltage (V)	14.4
Discharge Cut-off Voltage (V)	10.4
Max.Charge Current (A)	100
Max.Discharge Current (A)	150
Peak Discharge Current (A)	180A@10S 250A@2S
Recommend Discharge Current (A)	75
Recommend Discharge Depth (%)	80
Cycle Life	≥4000 cycles (25°C, 0.5C ) 80% DOD
Communication	Bluetooth
Charge&Discharge Temperature(°C)	Charge: 0°C~+50°C / Discharge: -20°C~+60°C
Optimal Storage Temperature(°C)	5°C ~ +35°C
Recommend Storage Humidity	20%~80%
Terminal	M8
Dimensions (L*W*H) (mm)	522*268*218
Weight (Kg)	17.9±0.5
Certificate	UN38.3, MSDS, IEC62619、CE-RED、ROHS
IP Class	IP65



Different Rate Discharge Curve@25°C

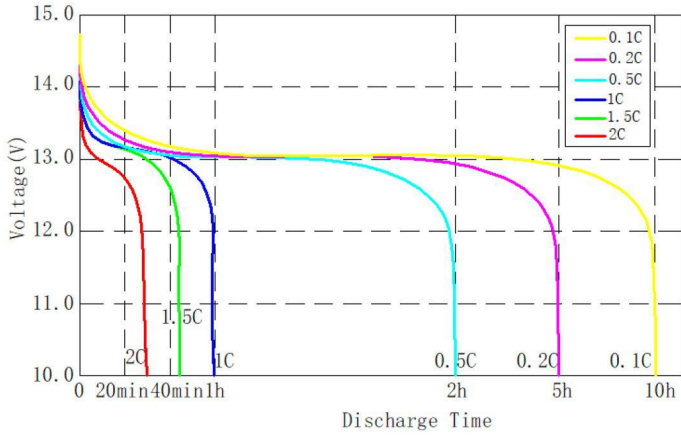

Different Temperature Discharge Curve@0.5C

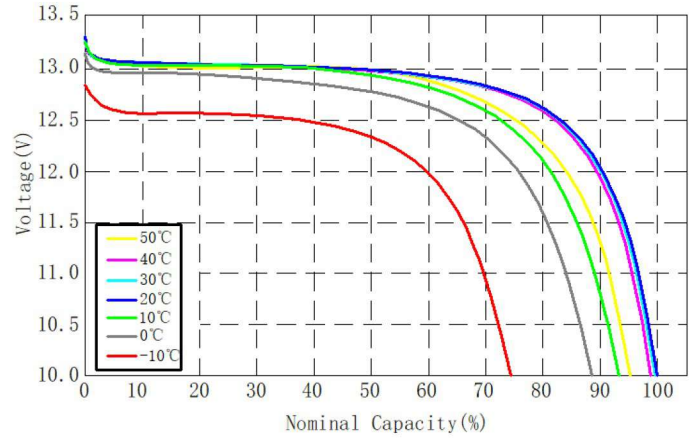

State of Charge Curve@0.5C 25°C

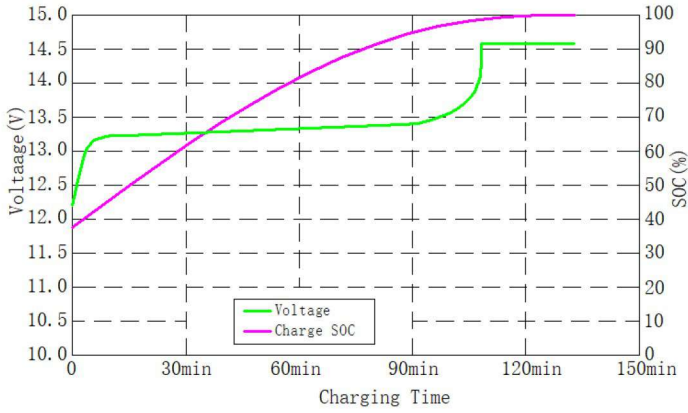

Charging Characteristics @0.5C 25°C

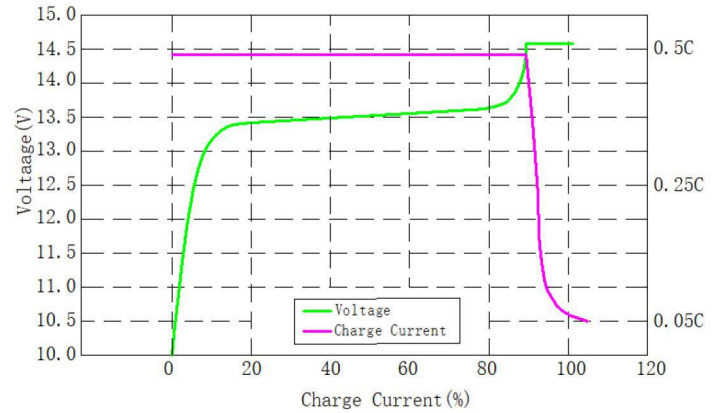

Different DOD Discharge Cycle Life Curve@0.5C 25°C

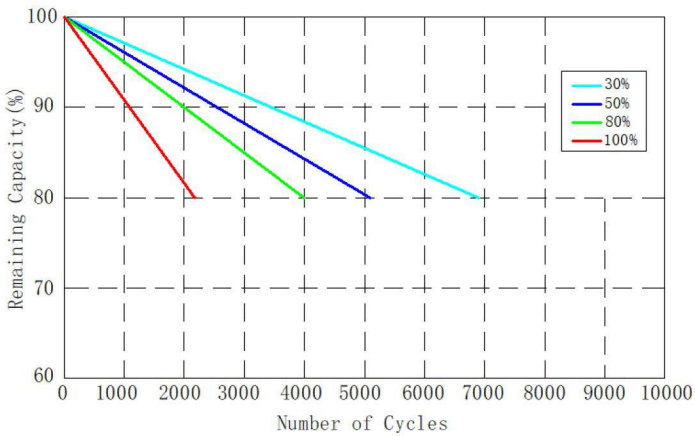

Different Temperature Self Discharge Curve

