

Remote Meter User Manual

EN



MT52



Contents

Important Safety Instructions	1
1 General Information	3
1.1 Features	3
1.2 Main functions	3
1.3 Recommendations	4
2 Installation	6
3 Product Features	9
4 Operation	15
4.1 Buttons	15
4.2 Main menu	16
4.3 Real-time monitoring	16
4.4 Device information	19
4.5 Test operation	19

4.6 Control parameter	20
4.7 Load setting	28
4.8 Device parameter	32
4.9 Device password	33
4.10 Factory reset	34
4.11 Failure information	34
4.12 Meter parameter	36
5 Warranty	38
6 Technical Specifications	39
Appendix Dimensions	41

Important Safety Instructions

Please keep this manual for future reference.

This manual contains all the safety, installation, and operating instructions for the remote meter.

General safety information

- Please inspect the MT52 thoroughly after it is delivered. If any damage is seen, please notify the shipping company or our company immediately. A photo of the damage may be helpful.
- Read all instructions and cautions in the manual before starting the installation.
- Keep the MT52 away from rain, exposure, severe dust, vibrations, corrosive gas, and intense electromagnetic interference.
- Avoid water entering the remote meter.
- There are no user-serviceable parts inside the remote meter. Do not disassemble or attempt to repair it.



Do not install this product in humid, salt spray, corrosion, greasy, flammable, explosive, dust accumulative, or other severe

WARNING

environment.

1 General Information

1.1 Features

The MT52 remote meter, using with the controllers designed with RS485 communication, can monitor the controller's real-time working status and program the parameters.

Features:

- Easy to install and operate
- Real-time display of fault alarms
- Locally reading of real-time parameters
- Powered by the controller directly
- Equipped with an RJ45 communication port

1.2 Main functions

Functions like real-time monitoring of system data, browsing and modifying related parameters, and restoring factory defaults are based on the LCD and functional key operation.

1.3 Recommendations

- **Applicable Models**

Product Series	Battery Type	Interface Type
LS-B, GM-N, VS-BN, Tracer-BN	Lead-acid battery, user define	RJ45
iTracer-AD/ND	Lead-acid battery, user define	3.81-4P
Tracer-BP⁽¹⁾	Lead-acid battery, user define	RS485 waterproof port
Tracer-CPN	Lead-acid battery, lithium battery, user define	
Tracer-AN (50A-100A)⁽¹⁾	Lead-acid battery, user define	RJ45
Tracer-AN (10A-40A), Tracer-AN G3, TRIRON, XTRA-N, XTRA-N G3	Lead-acid battery, lithium battery, user define	

(1) MT52 does not support lithium battery parameter setting for Tracer-BP and

Tracer-AN (50A-100A) series, if you need it, we recommend you to purchase EPEVER WiFi/Bluetooth/USB to RS485 communication cable and other accessories.

- **When the MT52 is connected with different devices, the configurable battery types are listed as the above table. For detailed battery types and setting method, refer to Section 4.6 Control parameter.**
- **Do not install the MT52 in a situation with strong electromagnetic interference.**
- **The MT52 comes standard with an RS485 communication cable (CC-RS485-RS485-200U). If it is connected to a controller with a not standard RJ45 interface, please purchase an appropriate communication cable in advance.**

2 Installation

- Frame mount dimensions (mm)

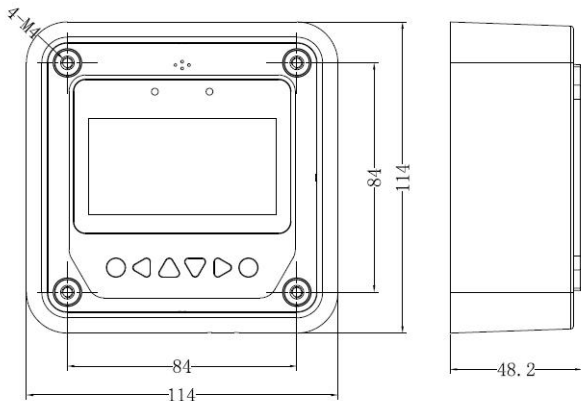

Mechanical Parameter	Parameter
Overall dimension	114mm × 114mm × 48.2mm

Mounting dimension	84mm × 84mm
Screw hole dimension	5mm

• Mounting on the wall

Step 1: Locate and drill screw holes based on the frame mounting dimension of the base, and install the plastic expansion bolts.

Step 2: Fix the frame with four ST4.2 × 3 self-tapping cross recessed pan head screws.

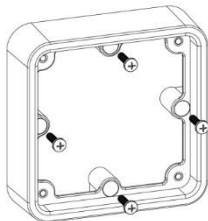

Step 3: Use four M4 × 8 pan head screws to mount the MT52 panel on the frame.

Step 4: Mount the four associated screw plugs into the screw holes.

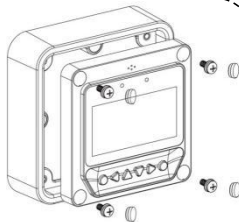

• Mounting on the panel surface

Step 1: Locate and drill screw holes based on the installation size of the surface.

Step 2: Use four M4 × 8 cross recessed pan head screws with M4 nuts to mount MT52 panel onto the surface.

Step 3: Mount the four associated white screw plugs into the screw holes.

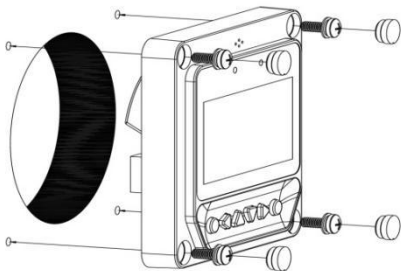

Note: Take full consideration of the plugging/unplugging space and the length of the communication cable during installation.

3 Product Features

➤ **Front view**

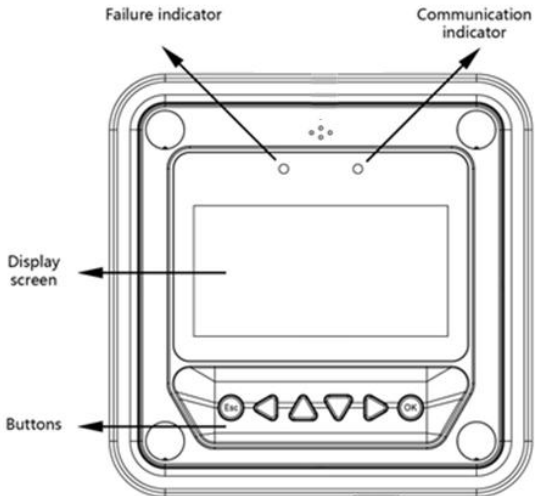

➤ **Back view**

RJ45 interface

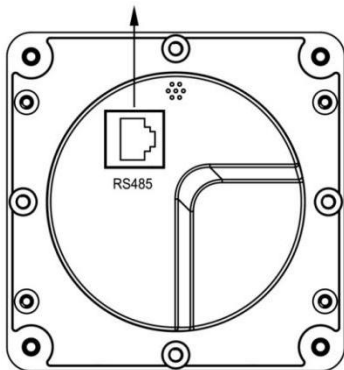

Module	Function
Failure indicator	Failure indicator flashes when there is fault occurs. Refer to the user manual of the controller for detailed failure information.
Communication indicator	Indicate the communication status between MT52 and the connected controller.
Display screen	Man-machine interface. Note: The display screen can be viewed clearly when the angle between the end-user's horizontal sight and the display screen is within 90°, and the screen cannot be







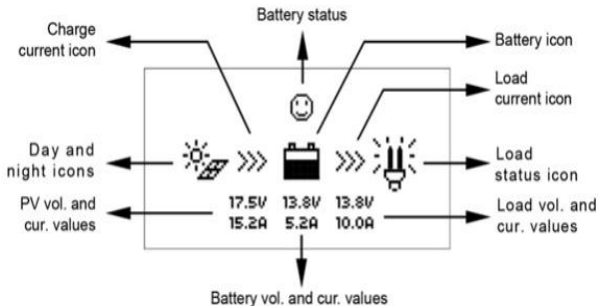



	viewed clearly when the angle exceeds 90°.
Buttons	Include four navigation buttons and two operational buttons. Refer to the 4.1 Buttons for specific directions.
RJ45 interface	Connect with the controller; and it is used for communication and power supply.

Note: Please use the communication plug, marked with "MT," to connect MT52.

➤ Monitoring screen



Name	LCD Display	Instruction
Day and night icons		Night

		Day Note: The threshold voltage is 1V. When it goes higher than 1V, it is daytime.
Charge current icon		The icon is dynamically running when there is a charge current.
Battery icon	 	The battery capacity is dynamically displayed. Note: When the battery is over-discharged, this icon is displayed as 
Battery status icons		Normal battery voltage
		Battery under voltage
		Battery over-discharge
Load current icon		The icon is dynamically running when there is a discharge current.
Load status icon		Load On

		<p>Load Off</p> <p>Note: In the Manual Mode, press the "OK" button to switch on/off the load.</p>
PV vol. and cur. values	<p>17.5V 15.2A</p>	Display the PV voltage and current values.
Battery vol. and cur. values	<p>13.8V 5.2A</p>	Display the battery voltage and current values.
Load vol. and cur. values	<p>13.8V 10.0A</p>	Display the load voltage and current values.



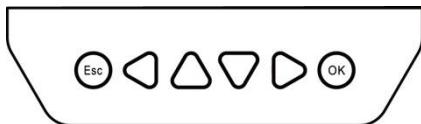

4 Operation

4.1 Buttons

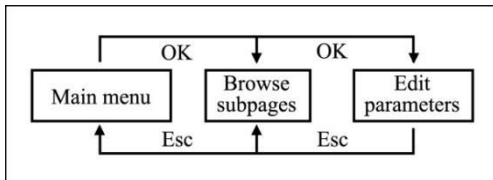

The buttons are respectively (from left to right) "ESC," "Left," "Up," "Down," "Right," and "OK". The operation is described in the diagram below:



The default entry page is the browse mode. Press the  button and input the correct password to enter the modification mode.  and  buttons could be used to move the cursor.  and  buttons could be used to modify the parameter

values when the cursor is located at the current place. **OK** and **Esc** buttons could be finally used to confirm and cancel the modification of the control parameters.

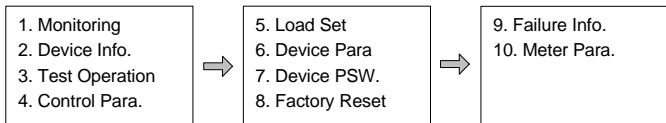

4.2 Main menu

Enter the Main Menu by pressing **Esc**. The **↑** and **↓** buttons are respectively used to move the cursor to select the menu items, **OK** and **Esc** buttons are respectively used to enter or exit the corresponding pages of the menu items.



4.3 Real-time monitoring

There are 13 pages under real-time monitoring. Please check it as below:

		
17.5V	13.8V	13.8V
15.2A	5.2A	10.0A



Jan-01-2013
02:34:33



Char. Energy
Day: 0.00kwh
Mon: 0.00kwh
Total: 0.00kwh



DisCh. Energy
Day: 0.00kwh
Mon: 0.00kwh
Total: 0.00kwh



Battery
Vol: 0.0V
Cur: 0.0A







Battery
Temp.: 22.4°C
Max. Vol: 12.7V
Min. Vol: 12.7V

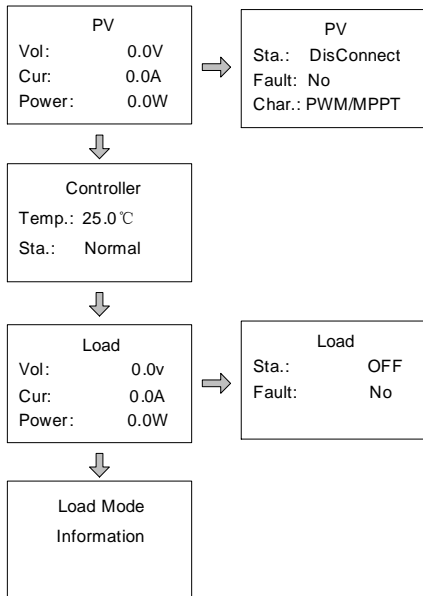

Battery
Charge: NoCharge
Energie: Normal
Fault: No







Operational tips: Move between rows by pressing the  or  buttons. Move along a row by pressing the  or  buttons.

4.4 Device information

The controllers' parameters are displayed below:





Rate.Vol:	12V
Char.Cur:	10.0A
Disc.Cur:	2.6A

Operational tips:  and  buttons are respectively used to turn the browse page up and down.

4.5 Test operation

Load switch test is conducted on the connection solar controller to check if the load output is normal. The test does not affect the working settings under actual load, which means that the solar controller will exit from the test mode when exiting the Test Operation page.

Test Operation	
LS****B:	OFF

Operational tips: Enter the page and input the correct password; use  and  buttons to modify the On/Off status. Press  to confirm and press  to

cancel the test.

4.6 Control parameter

Browse, and modification operations are conducted over the control parameters of the solar controller. See the scope of parameter modification in the control parameters table and the page of control parameters in the diagram below:

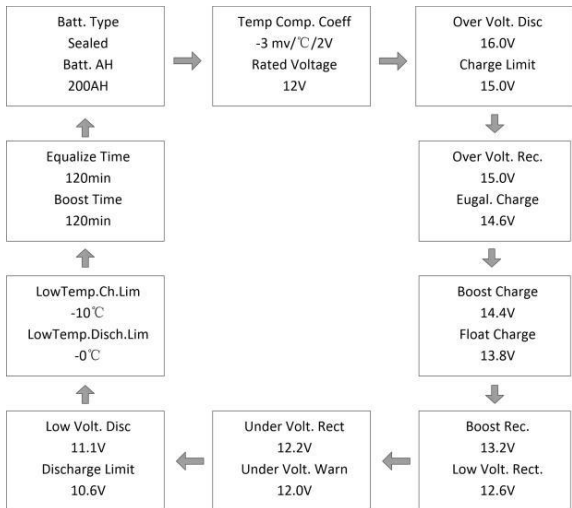

1) Batt. Type

Supported battery types are shown as below.

1	Lead-acid battery	Sealed (default)
		Gel

		Flooded
2	Lithium battery	LiFePO4 (LFP4S, LFP8S, LFP15S*, LFP16S*)
		Li(NiCoMn)O2 (LNCM3S, LNCM6S, LNCM7S, LNCM13S*, LNCM14S*)
3	User define♦	

★ The battery type will display LiFePO4 15S/16S and Li(NiCoMn)O2 13S/14S only when the controller connected to the MT52 supports 48V system voltage.

♦ When modifying the battery type to "USE," the default voltage point is the corresponding voltage before the battery type is modified.

2) Parameters of the Batt. AH, Temp Comp. Coeff and Rated Voltage

Parameter	Default	Range
Batt. AH (Battery capacity)	200Ah	1 to 9999Ah
Temp Comp. Coeff (Temperature compensation coefficient*)	-3mV/°C/2V	0 to -9mV/°C/2V
Rated Voltage*	Auto	Auto/12V/24V/36V/48V

★ When the battery type is selected as the lithium battery (LiFePO4 and Li(NiCoMn)O2 series), the "Temp Comp. Coeff " and the "Rated Voltage" cannot be set. The software automatically enables the protection function of "Low temperature prohibits charge and discharge."

3) Voltage parameters

- **Battery voltage parameters**

The below parameters are measured in the condition of 12V/25°C. Please double the values in the 24V system and multiplies the values by 4 in the 48V system.

Battery charging Setting	Sealed	Gel	Flooded	User
Over voltage disconnect voltage	16.0V	16.0V	16.0V	9–17V
Charging limit voltage	15.0V	15.0V	15.0V	9–17V
Over voltage reconnect voltage	15.0V	15.0V	15.0V	9–17V
Equalize charging voltage	14.6V	--	14.8V	9–17V
Boost charging voltage	14.4V	14.2V	14.6V	9–17V
Float charging voltage	13.8V	13.8V	13.8V	9–17V
Boost reconnect charging Voltage	13.2V	13.2V	13.2V	9–17V
Low voltage reconnect voltage	12.6V	12.6V	12.6V	9–17V
Under voltage warning reconnect voltage	12.2V	12.2V	12.2V	9–17V

Under voltage warning voltage	12.0V	12.0V	12.0V	9—17V
Low voltage disconnect voltage	11.1V	11.1V	11.1V	9—17V
Discharging limit voltage	10.6V	10.6V	10.6V	9—17V
Equalize duration	120min	--	120min	0—180min
Boost duration	120min	120min	120min	10—180min

• **When the battery type is "USE," the battery voltage parameters follow the following logic:**

- A. Over Voltage Disconnect Voltage > Charging Limit Voltage \geq Equalize Charging Voltage \geq Boost Charging Voltage \geq Float Charging Voltage > Boost Reconnect Charging Voltage.
- B. Over Voltage Disconnect Voltage > Over Voltage Reconnect Voltage
- C. Low Voltage Reconnect Voltage > Low Voltage Disconnect Voltage \geq Discharging Limit Voltage.
- D. Under Voltage Warning Reconnect Voltage > Under Voltage Warning Voltage \geq Discharging Limit Voltage;
- E. Boost Reconnect Charging voltage > Low Voltage Reconnect Voltage.

• **Lithium Battery voltage parameters**

Battery type	LFP
---------------------	------------

Battery parameters	LFP4S	LFP8S	LFP15S	LFP16S	User ^①
Over voltage disconnect voltage	14.5V	29.0 V	54.7V	58.4V	9–17V
Charging limit voltage	14.3 V	28.6 V	53.6V	57.2V	9–17V
Over voltage reconnect voltage	14.3 V	28.6 V	53.6V	57.2V	9–17V
Equalize charging voltage	14.2 V	28.4 V	53.3V	56.8V	9–17V
Boost charging voltage	14.2 V	28.4 V	53.3V	56.8V	9–17V
Float charging voltage	13.3 V	26.6 V	50.0V	54.0V	9–17V
Boost reconnect charging voltage	13.0 V	26.6 V	49.7V	52.0V	9–17V
Low voltage reconnect voltage	12.8 V	25.6 V	48.0V	51.2V	9–17V
Under voltage warning reconnect voltage	12.2 V	24.4 V	45.7V	48.8V	9–17V
Under voltage warning voltage	12.0 V	24.0 V	45.0V	48.0V	9–17V
Low voltage disconnect voltage	11.3 V	22.6V	42.5V	45.2V	9–17V
Discharging limit voltage	11.0 V	22.0 V	41.5V	44.0V	9–17V

① The battery parameters under the "User" battery type is 9–17V for LFP4S. They should × 2 for LFP8S, and × 4 for LFP15S/LFP16S.

Battery type Battery parameters	LNCM					
	LNCM 3S	LNCM 6S	LNCM 7S	LNCM 13S	LNCM 14S	User [®]
Over voltage disconnect voltage	12.8 V	25.6 V	29.8 V	55.4V	59.7V	9–17V
Charging limit voltage	12.6 V	25.2 V	29.4 V	54.6V	58.8V	9–17V
Over voltage reconnect voltage	12.5 V	25.0 V	29.1 V	54.1V	58.3V	9–17V
Equalize charging voltage	12.5 V	25.0 V	29.1 V	54.1V	58.3V	9–17V
Boost charging voltage	12.5 V	25.0 V	29.1 V	54.1V	58.3V	9–17V
Float charging voltage	12.2 V	24.4 V	28.4 V	52.8V	56.9V	9–17V
Boost reconnect charging voltage	12.1 V	24.2 V	28.2 V	52.4V	56.4V	9–17V
Low voltage reconnect voltage	10.5 V	21.0 V	24.5 V	45.5V	49.0V	9–17V
Under voltage warning reconnect voltage	12.2 V	24.4 V	28.4 V	52.8V	56.9V	9–17V

Under voltage warning voltage	10.5 V	21.0 V	24.5 V	45.5V	49.0V	9–17V
Low voltage disconnect voltage	9.3 V	18.6 V	21.7 V	40.3V	43.4V	9–17V
Discharging limit voltage	9.3 V	18.6 V	21.7 V	40.3V	43.4V	9–17V

① The battery parameters under the "User" battery type is 9–17V for LNCM3S. They should × 2 for LNCM6S/LNCM7S, and × 4 for LNCM13S/LNCM14S.

• When the battery type is "USE," the Lithium battery voltage parameters follow the following logic:

- A. Over Voltage Disconnect Voltage > Over Charging Protection Voltage (Protection Circuit Modules(BMS)) + 0.2V;
- B. Over Voltage Disconnect Voltage > Over Voltage Reconnect Voltage = Charging Limit Voltage ≥ Equalize Charging Voltage = Boost Charging Voltage ≥ Float Charging Voltage > Boost Reconnect Charging Voltage;
- C. Low Voltage Reconnect Voltage > Low Voltage Disconnect Voltage ≥ Discharging Limit Voltage.
- D. Under Voltage Warning Reconnect Voltage > Under Voltage Warning Voltage ≥ Discharging Limit Voltage;
- E. Boost Reconnect Charging voltage > Low Voltage Reconnect Voltage;

- F. Low Voltage Disconnect Voltage \geq Over Discharging Protection Voltage
(BMS) + 0.2V

4.7 Load setting

The page of load setting could be used to set the four load working modes of the connection solar controller (Manual, Light on/off, Light on + timer, Time control).

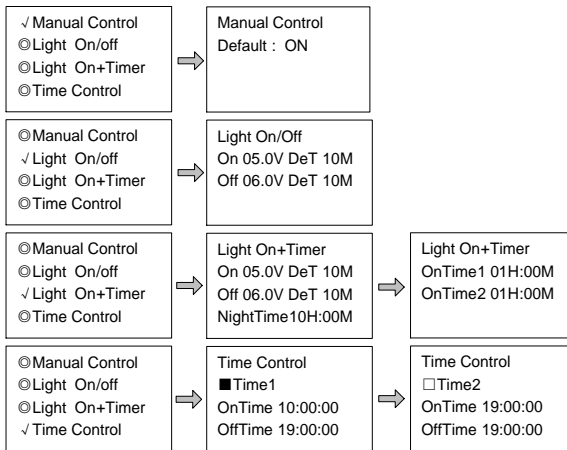

Note: For detailed instructions on load settings, please refer to the relevant solar controller manual.

1. Manual control

Mode	Introductions
ON	The load is on if the battery capacity is enough and no abnormal conditions happen.

OFF	The load is off all the time.
-----	-------------------------------

2. Light On/Off

Light On voltage (Night threshold)	<p>The load output is automatically turned on when the below situations occur at the same time:</p> <ol style="list-style-type: none"> 1. The PV input voltage is lower than the Light On voltage. 2. The battery capacity is enough. 3. No abnormal conditions happen.
Light Off voltage (Day threshold)	When the PV input voltage is higher than the Light Off voltage, the load output is automatically turned off.
Delay time	It means the confirmation time for the light signal. During this period, if the light signal voltage continues matching the Light On/Off voltage, the controller will perform corresponding actions (the time adjustment range: 0–99mins).

3. Light On+ timer

Working time 1 (T1)	Load working period after light control turns on the load	Any working time is set as "0," it means to stop working. The real
------------------------	---	--

Working time 2 (T2)	Load working period before light control turns off the load
Night-time	Total night-time by calculation (\geq 3h)

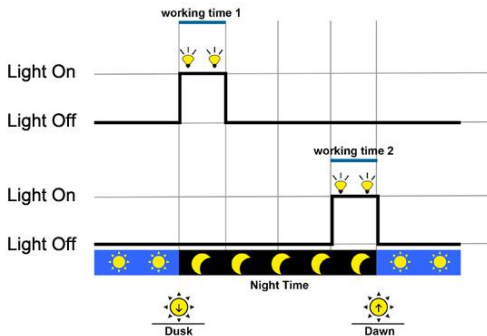

4. Time control

Working time1 (T1)	Control on/off time of the load through real-time clock mode.	Working time 1 is the compulsory load working time interval. Working time 2 is optional.
Working time2 (T2)	Realize the dual timer function of the load control through real-time clock mode.	

4.8 Device parameter

The solar controller's software version could be checked via the device parameter page. And device data like device ID, device LCD backlight time, and device clock could also be checked and modified. The device parameter page shows in the diagram

below:

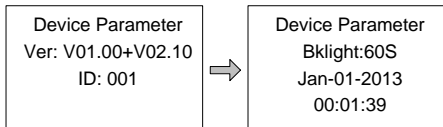

Note:

1. The bigger the connection device's ID value, the longer the communication identification interval will be (the maximum interval < 6 minutes).
2. For detailed instructions on device parameters, please refer to the relevant solar

controller manual.

Type	Notes
Ver	It indicates the Solar controller's software and hardware version numbers.
ID	It indicates the Solar controller's communication ID numbers.
Bklight	It indicates the Solar controller's LCD backlight time.
Month-Day-Year H: M: S	It indicates the Solar controller's internal clock.

4.9 Device password

The solar controller's password could be modified via the device password page. The device password is a 6-digit figure which is required before entering the modification mode of "Control parameter," "Load setting," "Device parameter," "Device password," "Factory reset" pages. The page of the device password in the diagram shows as below:

Device PSW OriPsw:xxxxxx NewPsw:xxxxxx
--

Note: The default password of the solar charge controller is" 000000".

4.10 Factory reset

The solar charger controller's default parameters could be restored via the Factory reset page. Including the "Control parameter," "Load setting," "Charge mode," and "Device password" could all be restored to the factory defaults (the factory default password of the devices is "000000").

Factory Reset
Yes No

4.11 Failure

information

The solar controller's failure information could be checked via the Failure information page (a maximum of 15 failure messages could be displayed). After the solar controller's failures are eliminated, the corresponding failure information will also be automatically eliminated.

Failure Info
1.Over voltage
2.Over load
3.Short circuit

Common failure information

Failure type	LCD display	Instructions
Charging device failures	Load MOS-Short	The MOSFET of the load driver is short-circuited.
	Load Circuit	The load circuit is short-circuited.
	Load O. cur.	The load circuit is over current.
	Char. MOS-Short	The MOSFET of the charge driver is short-circuited.
	Input vol. High	The input voltage is very high.
Controller failure	Ctrlr O. Temp.	The controller is over-temperature.
Communication failure	Comm. Timeout	The communication is timeout.
Battery failures	Batt. O. Hi. Temp.	The battery is over high temperature.
	Batt. O. Lo. Temp.	The battery is over low temperature.
	Rated Vol Err.	The rated voltage is in error.
	Batt. OVD	The battery voltage exceeds the over voltage disconnect (OVD) voltage value.
	Batt. UVW	The battery voltage is lower than the

		under voltage warning (UVW) voltage value.
	Batt. LVD	The battery voltage is lower than the low voltage disconnect (LVD) voltage value.
	Batt. Err	The battery type is in error.

4.12 Meter parameter

The meter's model, software, and hardware version could be checked via the meter parameter page. And the two parameters (Switch pages, Backlight) could be browsed and modified as well.



On the above anyone page, long-press + + + at the same time to enter the language selection page:

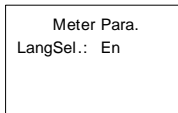

Parameters	Default	Range	Remark
Sw-Pages	0	0–120S	Set the automatic switching interval for the real-time monitoring pages.
BKlight	20	0–999S	Set the LCD backlight time.
LangSel.	Cn	Cn/En	Switch the display language between Chinese and English.

5 Warranty

Maintenance Procedure

Refer to the user manual or contact after-sales personnel to solve the faults before requiring maintenance. If it is confirmed that the maintenance needs to be carried out at the factory, send the product to our company by express delivery, prepay the shipping cost, and provide purchase invoice as the basis for warranty.

Indicate the model number, usage environment data, and a detailed description of the fault on the returned product to obtain the quick warranty service. This information is important for addressing your repair requirements.

If the device is damaged due to customer's improper use or failure to follow this user manual, we will not be responsible!

The maintenance follows the above procedures, and the maintenance costs will occur during the maintenance process.

6 Technical Specifications

Electrical Parameter	
Self-consumption	Backlight ON < 23mA
	Backlight OFF < 15mA
Mechanical Parameter	
Faceplate dimension	98mm × 98mm
Frame dimension	114mm × 114mm
Communication port	RJ45
Communication cable (m)	Standard: 2m, Longest: 50m
Net weight	Simple package: 0.23Kg
	Standard package: 0.32kg
Environmental Parameter	
Environment temperature	-20°C to +70°C

RJ45 pin definition:

Pin No.	Definition
1	+5-12V Power input
2	+5-12V Power input
3	RS485-B
4	RS485-B
5	RS485-A
6	RS485-A
7	GND
8	GND

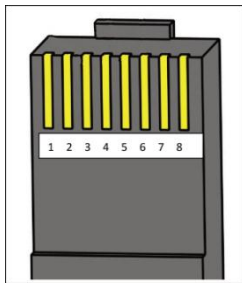

Data cable pin definitions

Appendix Dimensions

Unit: mm

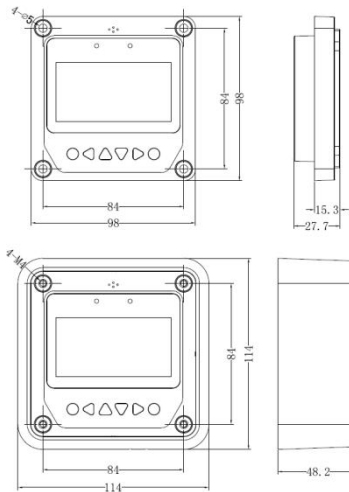

Any changes without prior notice!

Version number: V1.2



SolarV GmbH

Tel: +4961969076877

E-mail: info@solarv.de

www.solarv.de